

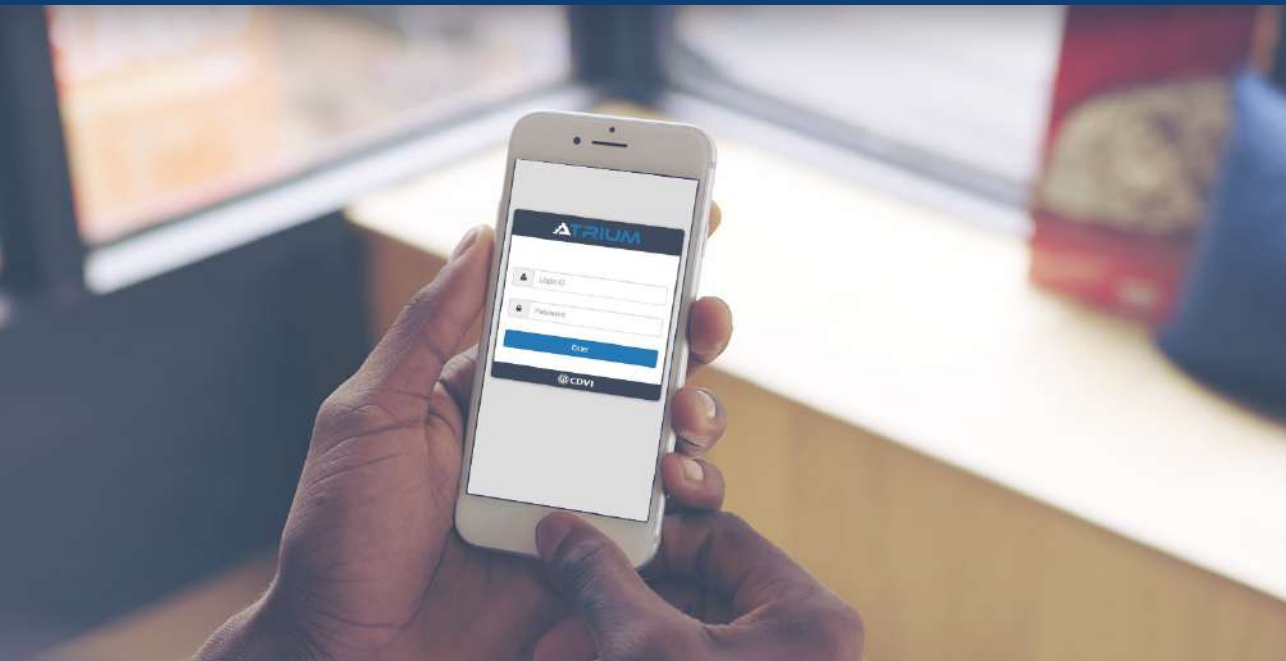

# CDVI

Security to Access



# CATALOGUE

# 2021

EDITION 1

Dear Customer,

Welcome to CDVI's new product catalogue for 2021.

This edition includes hundreds of products covering every area of access control, from online access control to door automation and video door entry. The catalogue is organised into simple navigable sections, allowing you to find what you're looking for and build solutions for your customers quickly and easily.

There are a number of exciting new additions to this catalogue. The new KRYPTO range of high security access control products brings military-grade encryption technology to the wider market, while making installation and programming easier than ever.

This year, CDVI expanded its offering through the acquisition of ievo, a specialist manufacturer of biometric fingerprint readers. Offering high security, reliability, and aesthetics, ievo biometric solutions represent an exciting new generation of access control - discover the range on page 10.

This catalogue contains over 300 of our featured and selected products. To discover our full range, visit our website at [www.cdvi.co.uk](http://www.cdvi.co.uk), where you'll find datasheets, manuals, brochures, schematic drawings and more information on every product.

As always, everything we do at CDVI contributes to our commitment to the highest levels of customer care. Our unique 10-year warranty is our promise to you that purchasing through CDVI is not just a transaction - it's an ongoing relationship of support. You can get in touch with us from 8.30am to 5.30pm Monday to Friday via phone, email, web chat, or social media with any enquiry.

I hope that this product catalogue will be a handy and useful accompaniment to help you meet all your access control needs.

Thank you for your custom and continued support.

Paul Ramsay  
General Manager  
[paul.ramsay@cdvi.co.uk](mailto:paul.ramsay@cdvi.co.uk)

[www.cdvi.co.uk](http://www.cdvi.co.uk)  
[sales@cdvi.co.uk](mailto:sales@cdvi.co.uk)  
+[44] (0) 1628 531 300



<b>Product Category</b>	<b>Page</b>
ATRIUM Online Access Control	4
ievo Biometric Entry Solutions	10
CENTAUR Access Control	14
Readers & Cards	22
DIGIWAY Door Automation	30
Keypads	38
Standalone Access Control	42
Transmitters & Receivers	44
Electric Strikes	54
Magnetic Architectural Handles	60
Electro-Magnetic Locks	66
Electric Locks	76
Accessories	80
Power Supplies	90
Reader & Intercom Posts	94
2EASY Video Door Entry	98

This is an **interactive** catalogue. You can click on different elements to navigate within the document or open web pages with more information about products. On any page, you can click on **this button** to return here to the Contents page.





## ATRIUM Access Control

ATRIUM is a web-based access control system with capacity for up to 500 doors and 10,000 users. Developed with the end user in mind, ATRIUM benefits from an intuitive web portal and free software for remotely controlling access across multiple sites from any device.

Through seamless integration to CCTV and security alarm systems, ATRIUM forms an essential part of any robust building management strategy. Additional benefits include comprehensive reporting for full site and user visibility, and a wide range of compatible readers, keypads, and access credentials.

Continually updated to maintain its position at the leading edge of access control technology, latest developments include the introduction of the KRYPTO high security range, encrypted to at least AES128-standard from end to end.

Contents	Page
KRYPTO High Security Solution	6
ATRIUM Controllers	7
ATRIUM Ancillaries	9



### Secure Access Control

ATRIUM is a **complete solution** for all access control requirements in any industry. With a secure web portal and wide range of **stylish readers**, ATRIUM is the ideal access control solution for any premises.



### Intuitive Management

From the ATRIUM web portal, accessible on any web-enabled device, users can **manage credentials**, monitor alarms, generate reports, configure entire sites, and **interface** with third-party systems.



### Full Control & Visibility

The ATRIUM user interface offers a complete suite of **comprehensive reporting** functionality. From holistic **site-wide** analysis to detailed **granular** reports, ATRIUM enables end-to-end system visibility.



### Seamless Integration

ATRIUM's open SDK (Software Development Kit) makes integrating **easy**. Our IP integration with Texecom intruder alarms facilitates **innovative** lockdown, evacuation, and invacuation features.





# KRYPTO

## HIGH SECURITY SOLUTION

New high security  
**ATRIUM** controller for  
 up to **500 doors** and  
**10,000 users**

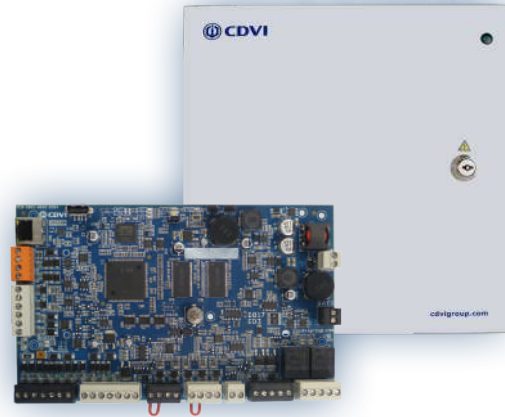

Third generation of **ATRIUM**  
 access control solutions

Military-grade encryption  
 technology as standard

Mobile credentials with 5  
 different activation types

Offering end-to-end encryption right out of the box and powerful Bluetooth enablement, it's never been easier to bring high security access control to homes and businesses.

Automatically create unique authentication keys per site and per credential, with no configuration card required. Combine with the new K Series of compatible readers and cards for a comprehensive high security solution.

## SAY 'NO' TO CARD CLONING

## A22 | 2-Door Controller

- Up to 500 doors and 10,000 users
- Built-in web server
- Includes free software and user interface
- Unique counter function to facilitate social distancing
- 230Vac
- 3.3A @ 24Vdc
- 290 x 280 x 80mm



Reference	Description
A22	ATRIUM 2-door controller
A22-POE	ATRIUM PoE Ultra controller
POE-I	PoE + injector

## A22K | High Security KRYPTO 2-Door Controller

- Area capacity management for social distancing
- End-to-end AES encryption
- Up to 500 doors and 10,000 users
- Includes free software, free app, and free Floorplan Manager
- **Now with 5 free mobile credentials licenses**
- 120-240Vac, 50/60Hz
- 250mA (default), 500mA, or 1A
- 290 x 280 x 80mm



Reference	Description
A22K	High security encrypted controller
AFPLAN	KRYPTO Floor Plan Manager license
AMC25	KRYPTO Mobile Credentials (25 pack)
AVISION	KRYPTO CCTV Manager license

## A22T | 2-Door Controller with Texecom Integration

- In-built server with Texecom integration
- Metal case for better security
- Up to 500 doors and 10,000 users
- Includes free software and free app
- 230Vac
- 3.3A @ 24Vdc
- 290 x 280 x 80mm



Reference	Description
A22T	ATRIUM/Texecom integration (A22 with firmware upgrade)

## AP22 | Aperio-Enabled Controller/Expander

- Metal case for better security
- Built-in PSU and battery charger
- Includes free software
- Up to 500 doors
- 230Vac
- 3.3A @ 24Vdc
- 290 x 280 x 80mm

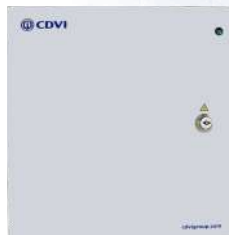

Reference	Description
AP22	ATRIUM Aperio-enabled controller/expander
AH30	Aperio hub
E100/C100/H100	Aperio wireless handle
PAP-TOOL	Aperio wireless USB programming tool

## AIOM | 10 Input/Output Module

- Metal case for better security
- Up to 20 inputs via zone doubling technology
- Powered from A22 controller (max. 2x AIOM per A22)
- Direct RS485 connection with A22
- 230Vac
- 3.3A @ 24Vdc
- 290 x 280 x 80mm



Reference	Description
AIOM	10 input/output module

## ADH10 | Schlage-Enabled Controller/Expander

- Enabled for integration with Schlage systems
- Built-in PSU and battery charger
- Built-in web server
- Up to 500 doors and 10,000 users
- 230Vac
- 3.3A @ 24Vdc
- 290 x 280 x 80mm



Reference	Description
ADH10	ATRIUM Schlage-enabled controller/expander
GWE	Gateway for NDE door handle
POE-I	PoE + injector

## USB Enrolment Readers

- Enters token numbers directly into ATRIUM database
- No driver required
- Works with Windows 7, 8, and 10
- Portable unit for multi-site use



Reference	Description
R125USB	Proximity enrolment reader, USB
R1356USB	MIFARE enrolment reader, USB

## A22-EC | Elevator Controller

- Metal case for better security
- Supports destination reporting with CAA-482P and CAA-480A
- Supports up to 64 floors
- Includes free software
- 230Vac
- 3.3A @ 24Vdc
- 290 x 280 x 80mm

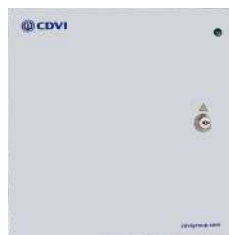

Reference	Description
A22-EC	ATRIUM elevator controller (A22 with firmware upgrade)
CAA-480A	16-floor lift control module
CAA-482P	Destination reporting module

## RX26-SAT | Pluggable Radio Receiver for ATRIUM

- Plugs directly into the ATRIUM controller
- Up to 100m range
- Rolling code security
- Tuned antenna included
- 12Vdc
- 24mA
- 105 x 45 x 28mm



Reference	Description
RX26-SAT	Pluggable radio receiver for ATRIUM
SEA433	Tuned aerial with L bracket for use with any TX26 series fob



**ievo**

# ievo Biometric Entry

ievo biometric entry solutions are designed to bring the high performance and high security of biometric technology to the access control market. Intended for seamless integration into a wide variety of access control systems, ievo combines ease of use with powerful next-generation functionality.

With fingerprint readers utilising best-in-class multi-spectral imaging (MSI) technology to analyse both the surface and subsurface of fingerprints, ievo offers a reliable biometric solution. The ievo Interface Board provides storage capacity for up to 50,000 fingerprints, ensuring a scalable system that will grow with you.

Designed and manufactured in the UK, ievo products are new to the CDVI range for 2021 and represent an exciting step towards the future of access control.

Contents	Page
ievo Overview	11
ievo Fingerprint Readers	12
ievo Ancillaries	13

## ievo Biometric Entry

**ievo**

Now **integrated** with ATRIUM access control for a seamless biometric entry system!

This year, we are delighted to introduce **ievo** biometric entry solutions to our product range.

ievo brings the next generation of access control technology to the wider market.



High security

High performance

High reliability

ievo ultimate™ utilises a multi-spectral imaging (MSI) sensor, simultaneously reading data from both the surface and subsurface levels of a fingerprint. Even when the print's features are hard to distinguish due to dirt, moisture, or damage, ievo offers an effective biometric entry solution.



**ievo ultimate™ is IP65-rated and features built-in environmental controls. Designed for external installation, this reader retains operational functionality even in harsh weather conditions.**



## ievo ultimate™ Fingerprint Reader

ievo ultimate™ is a CPNI-certified fingerprint scanner that combines an industry-leading multispectral imaging sensor with advanced security features.

A high-performance biometric solution, ievo ultimate reads from both the surface and subsurface fingerprint levels even when features are hard to distinguish due to dirt, moisture, and damage.

- 1:N matching up to 50,000 fingerprint templates\*
- Internal or external use (IP65 rated)
- AES128-bit encrypted data transmission (optional)
- Visual and audible feedback
- Flush or surface mount available
- 12V
- 600mA
- 128 x 93 x 93mm (surface mount)
- 153 x 119 x 47mm recessed (flush mount)



Reference	Description
IEVO-U	ievo ultimate™ fingerprint reader
IEVO-U+	ievo ultimate™ fingerprint reader and card

## ievo micro™ Fingerprint Reader

ievo micro™ is an advanced biometric solution for indoor use. With its best-in-class optical sensor, the micro delivers fast, accurate, and reliable biometric security.

Offering both simplicity and convenience, the micro is a cost-effective option that integrates seamlessly with a wide variety access control systems, including ATRIUM (pg.4).

- 1:N matching up to 50,000 fingerprint templates\*
- Ideal for small to medium sized facilities
- AES128-bit encrypted data transmission (optional)
- Visual and audible feedback
- Simple to install and easy to operate
- 12V
- 400mA
- 155 x 55 x 70mm (surface mount)
- 230 x 80 x 33mm recessed (flush mount)

\*only when used with ievo Interface Board



Reference	Description
IEVO-M	ievo micro™ fingerprint reader
IEVO-M+	ievo micro™ fingerprint reader and card

## ievo Interface Board

- Supports 2 readers and up to 50,000 fingerprints
- Dual-channel Wiegand output with LED indication
- 12-24V (ac/dc options) / 400mA-1.2A (head dependent)
- 93 x 128 x 27mm

Reference	Description
IEVO-MB10K	DC ievo interface board, 10,000 capacity
IEVO-MB10KPOE	PoE ievo interface board, 10,000 capacity
IEVO-MB50K	DC ievo interface board, 50,000 capacity
IEVO-MB50KPOE	PoE ievo interface board, 50,000 capacity



## ievo Registration Units

- Remotely manage fingerprint enrolment process via PC
- Powered by USB with no additional PSU required
- Timing of placement to image creation: 1.0sec
- High quality image resolution: 500dpi

Reference	Description
IEVO-UDR	USB desktop reader - ievo ultimate™
IEVO-MDR	USB desktop reader - ievo micro™
IEVO-HIDDR	USB desktop reader - HID omnikey



## ievo Power Supply

- Class I switch mode power supply
- Mains and battery level indicator
- Built-in charging and battery protection
- Internally fused
- 12-24V (ac/dc options)
- 400mA-1.2A (head dependent)

Reference	Description
IEVO-ANC-PSU	ievo 2A enclosed PSU
IEVO-ANC-PSU+	ievo 5A enclosed PSU



## ievo Display Screen

- LCD screen display for user ID
- Parameters customisable via web interface
- Can be wall-mounted
- Visual confirmation of event time and date status
- 12Vdc / 170mA
- 120 x 80 x 30.7mm

Reference	Description
IEVO-ANC-SCREEN	2-line LCD display screen





## CENTAUR Access Control

CENTAUR is an online access control system with the scalable capacity to solve any access control challenge. Expandable to up to 256 controllers and across 64 sites or 2,048 doors, CENTAUR is a solution that will grow with you.

The CTV900ATR controller is at the heart of every CENTAUR system. The secure CENTAUR server, all hardware expansion modules, multi-purpose inputs, card readers, keypads, and outputs are connected directly to the controller.

The lightning-quick responses, robust security, and remarkable stability make CENTAUR the professional's choice for access control.

Contents	Page	Contents	Page
CENTAUR Packages	15	Controllers & Modules	18
Managing 1 Site	16	Converters & Ancillaries	19
Managing Multiple Sites	17	CENTAUR Key Features	21

CENTAUR integrated access control software offers a complete access control solution, from secure server to readers and cards. From a single-door system to a complex multi-site installation with large numbers of individual card-holders, CENTAUR benefits from the flexibility and scalability to perform effectively to professional standards.

As the needs of your facility change, CENTAUR grows with you, expanding seamlessly to meet your requirements.

Choose the CENTAUR package that works for you:

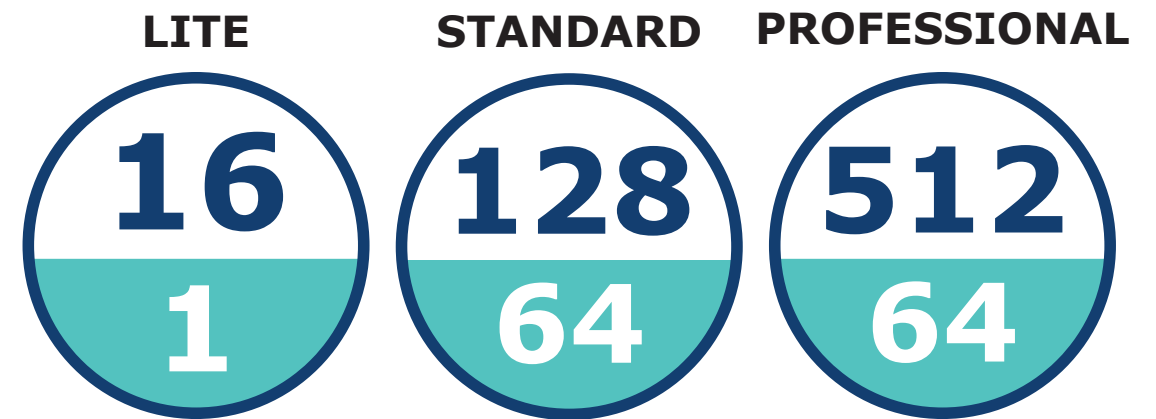

Up to 16 doors across 1 site

Up to 128 doors/site across 64 sites

Up to 512 doors/site across 64 sites

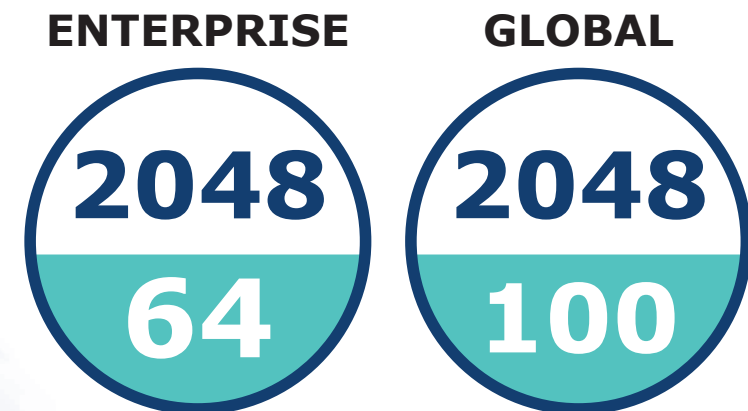

Up to 2,048 doors/site across 64 sites

Up to 2,048 doors/site across 100 sites



## Managing 1 Site with CENTAUR

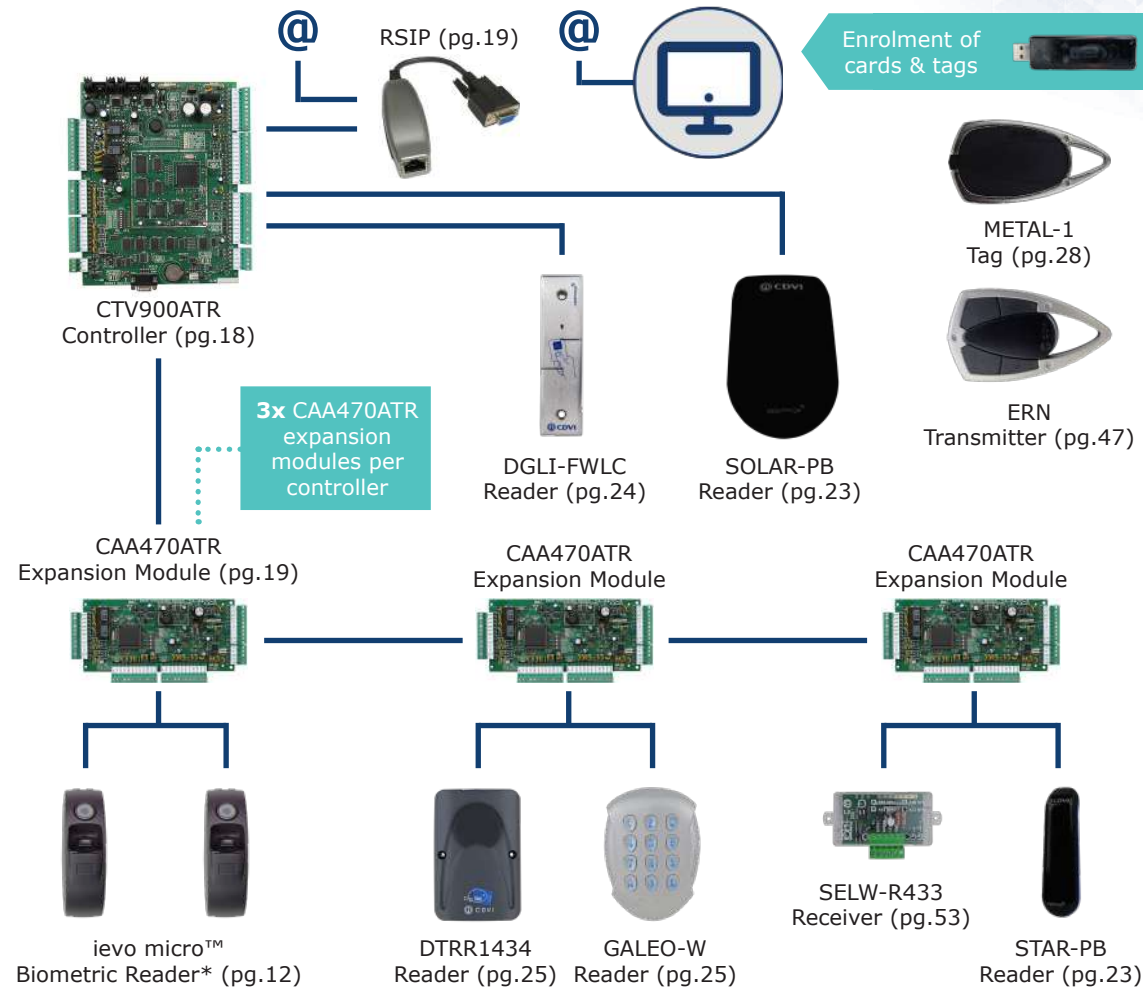

## Managing 1 Site with Time & Attendance with CENTAUR

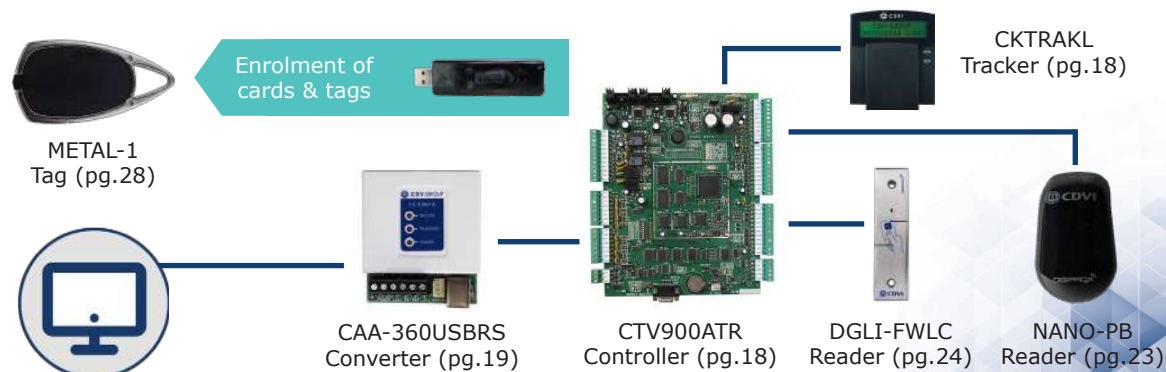

## Managing Multiple Sites Remotely with CENTAUR

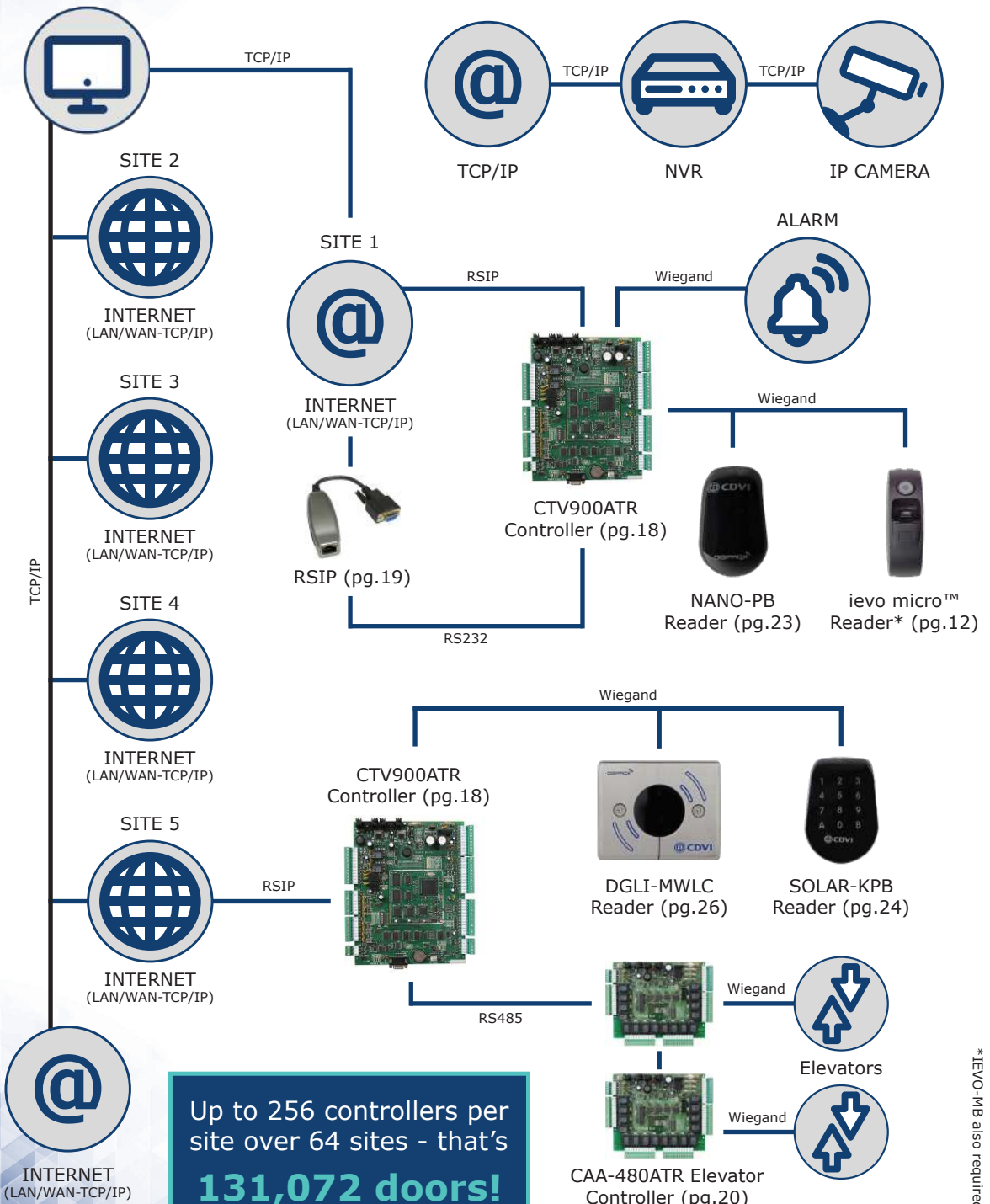

## CTV900ATR | 2-Door Controller

- 2-door intelligent controller
- Built-in power supply
- Secure metal case
- Accepts 3 expansion units
- Simple architecture to 2,048 doors
- 240Vac
- 2.5A @ 24Vdc
- 400 x 337 x 105mm



Reference	Description
CTV900ATR	CENTAUR 2-door controller
CS-STD6	CENTAUR standard software licence & key
CS-PRO6	CENTAUR professional software licence & key

## CAA-110P | Lock Control Module

- Simple double-lock installation
- 2x Form C relays
- 2x LEDs for relay status
- Directly plugs into CTV900ATR
- Outputs 5A @ 12Vdc
- 12Vdc
- 100mA

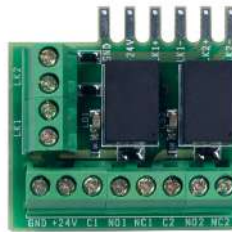

Reference	Description
CAA-110P	CENTAUR lock control module

## CKTRAKL | Time & Attendance Display-Tracker Module

- Backlit with adjustable contrast
- Supports display in different languages
- Connect up to 8 modules via E-bus
- Can be used with anti-passback
- 32-character LCD display (2 lines or 16 characters)
- 9 to 16Vdc
- 80mA



Reference	Description
CKTRAKL	Time and attendance display-tracker module

## CAA-470ATR | 2-Door Expansion Module

- 2-door expansion module
- Built-in power supply
- Secure metal case
- Ample space for cables
- Battery standby provision
- 240Vac
- Max 2.5A
- 298 x 285 x 78mm

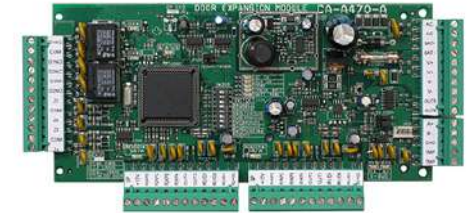

Reference	Description
CAA-470ATR	2-door expansion module

## CAA-360USBR5 | USB to RS485 Converter

- Interface for RS485 to USB for PC connection
- Standard RS485 max distance 1200m to furthest controller
- Includes 1m USB cable
- LED status indicators
- Suitable for UTP cable (Cat 5)
- 12Vdc
- 190mA
- 71 x 63 x 24mm



Reference	Description
CAA-360USBR5	USB to RS485 converter

## RSIP | RS232-TCP/IP Converter

- Easy programming and installation
- Creates TCP/IP protocol
- Static IP address
- Standard communication software configuration
- Detailed LED display



Reference	Description
RSIP	RS232-TCP/IP converter



## CAA-480A | Elevator Interface

- 16 relay outputs (activated by card or code)
- Control up to 64 floors and 2 elevator cabs (up to 128 relays)
- Preparation of reports relating to floor choice
- Direct connection to RS485 expansion bus
- Input for fire alarm
- 16Vac, 40VA, 50/60Hz
- Max 2.5A

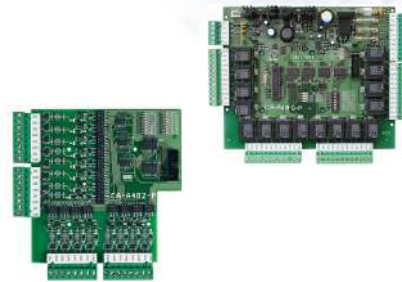

Reference	Description
CAA-480A	Elevator interface
CATR-1640	CAA-480A transformer
CAA-482P	Destination reporting module

## CAA-370P | RS485 Relay Hub for Star Configuration

- RS485 star configuration
- Isolates electrical "noise"
- Creates 4 independent RS485 networks from a single one
- Ideal for large areas
- LED indication for power, network and port activity
- 12Vdc
- Max 100mA



Reference	Description
CAA-370P	RS485 hub for star configuration

## CAA-460P | Relay Expansion Module

- 7 x Form C relay outputs (C/NO/NC)
- Maximum 2 x CAA-460P modules per CTV900ATR controller
- Direct connection to the expansion bus (E-Bus)
- 1220m max
- 12Vdc
- 50mA - 400mA



Reference	Description
CAA-460P	Relay expansion module

# Full control with complete flexibility

Intelligent CENTAUR systems retain operational functionality even in the event of computer failure, by falling back on independent controllers.

The simple one-click interface and built-in support for 14 international languages makes day-to-day management easy.

Seamless integration with burglar alarm systems ensures a comprehensive security solution to keep people and property safe.

Standalone backup

Multi-language support

User-friendly interface

Burglar alarm integration



## CENTAUR grows along with you

CENTAUR elevator control is the ideal solution for buildings large and small, offering control for up to 512 elevator cabs and 64 floors per cab.

Customisable settings make it easy to assign specific floors to specific credentials. Comprehensive scheduling features additionally allow you to vary access control based on time and day.





# Readers & Cards

From the stylish and aesthetic to the traditional and robust, CDVI offers a wide range of readers and credentials suitable for any access control project.

All our readers benefit from multi-coloured LEDs which give clear visual indications of door status at any time. Designed to be easy to mount, installation is quick and simple, with no complicated programming required.

The range includes standard proximity readers as well as high security MIFARE® DESFire® EV2 options, all rigorously tested to the IK10 standard. Access credentials also include both traditional cards and stylish tags in both proximity and MIFARE® DESFire®.

This year, we are proud to introduce the new Bluetooth-enabled K Series readers (pg.27) as part of the high security KRYPTO access control system (pg.6).

<b>Contents</b>	<b>Page</b>	<b>Contents</b>	<b>Page</b>
Proximity Readers	23	NEW KRYPTO Readers	27
MIFARE® Readers	26	Access Cards & Tags	28

## Proximity Readers

### NANO & STAR | Proximity Readers

- Stylish design with reflective backlight
- Proximity - 125kHz
- Audible and visual feedback
- Comes pre-cabled (NANO 3000mm, STAR 450mm)
- Wiegand 26, 30 or 44 bit
- 12Vdc
- 100mA
- 70 x 43 x 23mm (NANO)
- 130 x 41 x 28mm (STAR)



IP	Reference	Description
53	NANO-PB	Compact proximity reader, black
10	STAR-PB	Narrow style proximity reader, black

### SOLAR | Proximity Reader

- Stylish design
- Reflective backlight
- Audible and visual feedback
- Available in black only
- Wiegand 26, 30 or 44 bit
- 12Vdc
- 100mA
- 130 x 90 x 28mm



IP	Reference	Description
53	SOLAR-PB	Standard proximity reader, black
10		

### Did you know...?

**The NANO, STAR, and SOLAR readers are IK10 rated, meaning they are certified to withstand up to 20 Joules of external mechanical impact.**

**IK10 is the highest possible rating for impact resistance.**



[Learn more about IP and IK ratings](#)

## MOONARWB | Flush Proximity Reader

- Stylish design with reflective backlight
- Proximity (125kHz) with audible and visual feedback
- UK back-box format
- Wiegand 26, 30, or 44 bit
- Terminal connection



- 12Vdc
- 100mA
- 92 x 84 x 12.5mm

IP 52	Reference	Description
	MOONARWB	Flush proximity reader in black or white

## KCPROX-WLC | Combined Proximity Reader & Keypad

- Stainless steel with reflective backlight
- Card & PIN for increased security
- Audible and visual feedback
- Wiegand 26, 30 or 44 bit
- Comes pre-cabled



- 12Vdc
- 120mA
- 190 x 43 x 27mm

IP 64	Reference	Description
IK 10	KCPROX-WLC	Combined proximity reader & keypad, stainless steel

## SOLAR-K | Combined Proximity Reader & Keypad

- Stylish design with built-in keypad
- Reflective backlight around edge of reader
- Proximity - 125kHz
- Audible and visual feedback
- Wiegand 26, 30 or 44 bit



- 12Vdc
- 150mA
- 130 x 90 x 28mm

IP 53	Reference	Description
	SOLAR-KPB	Combined proximity reader & keypad, black

## GALEO-W | Digicode® Keypad with Wiegand Output

- Backlit keypad, externally rated
- Stylish & vandal resistant
- Secure surface mount
- Wiegand 26 bit
- Comes pre-cabled



- 12Vdc
- 100mA
- 110 x 75 x 15mm

IP 64	Reference	Description
IK 10	GALEO-W	Digicode® keypad with Wiegand output

## DGLI-WLC | Stainless Steel Proximity Reader

- Robust stainless steel
- Vandal resistant fixings
- Three-colour LED and buzzer
- Wiegand 26, 30 or 44 bit



- 12Vdc
- 100mA
- 98 x 77 x 20mm (WLC)
- 140 x 35 x 22mm (FWLC)

IP 53	Reference	Description
IK 10	DGLI-WLC	Standard proximity reader, stainless
	DGLI-FWLC	Narrow-style proximity reader, stainless

## DTRR1434 | Long-Range Reader

- Hands-free reader
- Adjustable read range up to 15m
- Up to 20 badges read simultaneously
- Standard 26-bit wiegand output
- Compatible with DTXT5434 cards (pg. 29)



- 12 to 30Vdc
- 40mA
- 90 x 60 x 22mm

IP 54	Reference	Description
	DTRR1434	Long-range reader

## STAR1M | Narrow MIFARE® Reader

- MIFARE® standard - 13.56MHz
- Audible and visual feedback
- Wiegand 26, 30, or 44 bit
- Stylish narrow design
- Comes pre-cabled
- 12Vdc
- 100mA
- 130 x 41 x 28mm



IP 54	Reference	Description
IK 09	STAR1M	Narrow-style MIFARE® reader, black
	STAR1M-K	MIFARE reader kit with 10x shadow cards

## DGLI-MWLC | Stainless Steel MIFARE® Reader

- MIFARE® standard - 13.56MHz
- Vandal-resistant fixings
- Robust stainless steel
- Wiegand 26, 30, or 44 bit
- Terminal connection
- 12Vdc
- 100mA
- 98 x 77 x 20mm



IP 53	Reference	Description
	DGLI-MWLC	Standard MIFARE® reader, stainless

## Why Choose MIFARE® Technology?

### Practicality

MIFARE® cards and fobs are contactless, offering a hygienic solution for the post-COVID world. Contactless entry also means less wear and tear over time, keeping your access systems looking good and working well for longer.

### Security

MIFARE® credentials are unique, each with its own serial number. If a card is stolen or lost, any misuse is easy to track and stop. MIFARE® DESFire® technology also makes cloning extremely difficult, ensuring higher security for any premises.

## K2 | High Security Encrypted KRYPTO Reader

The new KRYPTO K2 MIFARE® DESFire® EV2 encrypted reader makes high security easy. Offering end-to-end encryption when combined with the A22K controller and compatible credentials, the K2 is factory-programmed for instant high security right out of the box. Automatically create unique authentication keys per site and per credential with a system that's quick to install, simple to operate, and easy to maintain.

- 13.56MHz MIFARE® Classic and DESFire® EV2 credentials
- OSDP-2 compatible
- Bluetooth-enabled for smartphone operation
- 5cm read range
- Three-colour visual and audio feedback
- Sleek and aesthetic design
- 12Vdc
- 200mA
- 127 x 47 x 21.5mm

IP 65	Reference	Description
IK 10	K2	MIFARE® DESFire® EV2 reader



## K3 | High Security KRYPTO Reader and Keypad

The KRYPTO K3 MIFARE® DESFire® EV2 encrypted reader with keypad offers end-to-end encryption when combined with the A22K controller and compatible credentials. The K3 is factory-programmed for instant high security right out of the box. Automatically create unique authentication keys per site and per credential with a system that's quick to install, simple to operate, and easy to maintain.

- Bi-technology with built-in reader and keypad
- 13.56MHz MIFARE® Classic and DESFire® EV2 credentials
- OSDP-2 compatible
- Bluetooth-enabled for smartphone operation
- 5cm read range
- Sleek and aesthetic design
- IP65 and IK10 rated
- 12Vdc
- 200mA
- 135 x 80 x 22.6mm

IP 65	Reference	Description
IK 10	K3	MIFARE® DESFire® EV2 reader with keypad





## METAL | Robust Access Fobs

- Proximity, MIFARE®, or DESFire® EV2 access fob
- Encased in metal for rugged use
- Stylish design
- Lifetime warranty
- 60 x 30 x 7mm



Reference	Description
METAL-1	Robust proximity fob
METAL	Robust MIFARE® fob
METAL-D	Robust DESFire® fob - only for use with KRYPTO high security range

## PPC | Standard Fob

- Proximity fob
- PVC construction
- Encapsulated
- Includes keyring
- Compatible with CDVI readers (pg. 22)
- 40 x 33 x 3mm



Reference	Description
PPC	Standard access fob

## BV | Access Cards

- MIFARE® format
- PVC card
- Credit card size
- 0.8mm thick
- Compatible with CDVI readers (pg. 22)
- 85 x 54 x 0.8mm

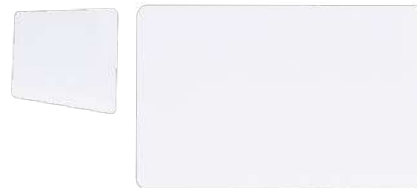

Reference	Description
BV	PVC MIFARE® access card
BM4K	PVC MIFARE® DESFire® access card

## BCD | High Security KRYPTO Access Card

- DESFire® EV2 4K format
- 13.56MHz proximity card
- Printable ISO card
- Compatible with KRYPTO range only
- 85 x 54 x 0.8mm



Reference	Description
BCD	High security DESFire® EV2 access card

## CPE & CPC | Proximity Cards

- Proximity access cards
- Manufactured in PVC
- CPE with slot for lanyard
- CPC suitable for printing
- 85 x 54 x 1.8mm (CPE)
- 85 x 54 x 0.8mm (CPC)



Reference	Description
CPE	Clamshell-style proximity access card
CPC	ISO printable proximity access card

## DTXT5434 | Hands-Free Active Cards

- Hands-free operation
- Up to 15m reader range
- Chargeable integral battery
- Compatible with DTRR1434 (Wiegand 26) and DTRR1434-R (standalone)
- CR2032, 3V battery cell
- 86 x 54 x 5mm



Reference	Description
DTXT5434	Hands-free active card
DTXT5434-P	Hands-free active card with proximity tag
DTXT5434-MI	Hands-free active card with MIFARE® tag
CLIPDIGITAGLR	Adhesive card holder



**DIGIWAY provides a universal automation solution for both interior and exterior doors, adaptable for both single and double doors.**

**With a built-in receiver and free programming app, all parameters can be quickly and easily configured for simple and successful installations.**



## DIGIWAY Door Automation

DIGIWAY is a universal automation solution for both interior and exterior doors, adaptable for both single and double doors. With a built-in receiver and free programming app, all parameters can be quickly and easily configured, making installations simple and successful.

DIGIWAY offers better accessibility, better security, and better hygiene in one simple solution. **DIGIWAY PLUS** is specifically designed to improve accessibility into and around buildings for people with reduced mobility, making it ideal for residential or care home projects. **DIGIWAY SR** (Spring Return) is additionally assisted by a chain-driven mechanism, making it particularly suitable for higher traffic sites. DIGIWAY SR is also fire rated to the EN1634-1 60-minute standard.

Easily integrated with access control readers, exit devices, and transmitters, DIGIWAY offers better building security and full visibility over the movement patterns of individuals.

Contents	Page	Contents	Page
Feature Overview	31	DIGIWAY Accessories	34
DIGIWAY PLUS or SR?	32	Compatible Ancillaries	36
DIGIWAY Kits	33		

### Backed by a 2-year warranty

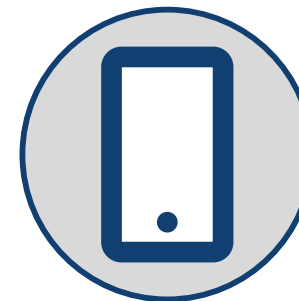

Bluetooth-enabled operator - programme quickly from the app



Up to 225,000 opening cycles a year for moderate to intensive use



Free installer training available from CDVI's in-house experts

### Safety First

The DIGIWAY Spring Return is **fire-tested** to the EN1634-1 standard, for withstanding fire for up to **60 minutes**.

DIGIWAY can be easily connected to fire signals to **automatically respond** in case of emergency. The door can be set to lock, unlock, close, or swing freely in the event of a fire.



## Which DIGIWAY is right for your project?

	DIGIWAY PLUS	DIGIWAY SR
<b>Max Door Weight*</b>	120kg	200kg
<b>Max Door Width*</b>	1.2m	1.5m
<b>Power</b>	50W	100W
<b>Dimensions (mm)</b>	511 x 50 x 110	685 x 90 x 110
<b>Lock Power</b>	12Vdc - 1A	12Vdc - 1A / 24Vdc - 0.5A
<b>Fire Input</b>	Power 24-48Vdc	NC contact
<b>Semi-Automatic Mode</b>	-	Yes
<b>Battery Failover</b>	Yes	-
<b>Spring Return</b>	-	Yes
<b>Software-Assisted Spring Pre-Load</b>	-	Yes
<b>Fire-Rated</b>	-	Yes

Reference	Description
DWPS102U	DIGIWAY PLUS door operator with universal arm
DWSR102U	DIGIWAY SR door operator with universal arm

\*At max door weight, width dimension reduces. Consult Suitability of Installation questionnaire for details.

## Did you know..?



You can use the Suitability of Installation questionnaires available on our website to check which DIGIWAY is right for your project.

Download for DIGIWAY SR

Download for DIGIWAY PLUS

All DIGIWAY products are fully compliant with the EN16005 standard, and facilitate monitored safety photocells in accordance with these regulations.

DIGIWAY kits come with your chosen door operator and all the required accessories to ensure that your installation complies with regulations.

Included in the kit:

- |                           |                                   |
|---------------------------|-----------------------------------|
| <b>DIGIWAY PLUS or SR</b> | Door operator with universal arm  |
| <b>DWSSS-5M1</b>          | 2x safety sensors                 |
| <b>DWS-FGB / DWS-FGW</b>  | Finger guard (black or white)     |
| <b>DWS-KCSIGN</b>         | 'Keep Clear' adhesive signage     |
| <b>DWS-ADSIGN</b>         | 'Automatic Door' adhesive signage |



Reference	Description
EN16005-KIT-U	DIGIWAY PLUS kit for single doors
EN16005-KIT-UD	DIGIWAY PLUS kit for double doors
EN16005-KIT-U-SR	DIGIWAY SR kit for single doors
EN16005-KIT-UD-SR	DIGIWAY SR kit for double doors



## Safety Sensors

- Adjustable range
- Selectable detection area
- Weathershield available for external use
- Ideal for DIGIWAY operators
- 12 to 24Vac/dc
- Max 110mA



**IP 54**

Reference	Description
DWSSS-5M1	Infrared safety sensor
DWWC-SSS5	Weathershield for DWSSS-5M1

## Activation Sensors

- Adjustable range
- Selectable detection area
- Weathershield available for external use
- Ideal for DIGIWAY operators
- 12 to 24Vac/dc
- Max 110mA



**IP 54**

Reference	Description
DWHR50-UNI	Microwave activation radar
DWHR50-WC	Weathershield for DWHR50-UNI

## Finger Guards

- Finger guard protector
- Covers gap on the hinge-line
- Available in black or white
- Compliant with EN16005 regulations
- Ideal for use with DIGIWAY
- 2,032mm length

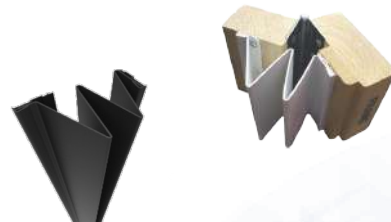

Reference	Description
DWS-FGB	Finger guards in black
DWS-FGW	Finger guards in white

## DWP-CS | Interconnecting Cable

- Interconnecting cable
- Allows automation of double doors
- Included in all DIGIWAY double door kits
- Compliant with EN16005 regulations
- 12 to 24Vac/dc
- 110mA max



Reference	Description
DWP-CS	Interconnecting cable for double doors

## DWSE Extensions

- Extension shaft for DIGIWAY arm
- Chromed steel
- Available in 30mm, 55mm, and 80mm
- 35mm diameter



Reference	Description
DWSE-30	30mm motor extension shaft
DWSE-55	55mm motor extension shaft
DWSE-80	80mm motor extension shaft

## DWSP-KS | Key Switches

- 3-position key switch
- Stainless steel outer
- Direct connection to DIGIWAY operator
- Internal & external use
- 10A @ 30Vdc
- 86 x 86 x 30mm (surface) / 2mm (flush)



**IP 53**

Reference	Description
DWSP-KS	3-position key switch for DIGIWAY, surface mount
DWSP-KF	3-position key switch for DIGIWAY, flush mount

All CDVI products are **fully compatible** with the DIGIWAY series, from exit devices and keypads to transmitters and mounting posts.

We recommend the following products as part of a comprehensive DIGIWAY solution, but this is not an exhaustive list. See each chapter section in this catalogue for information on our full ranges.

### Recommended Exit Devices

- High-quality stainless steel fronts
- Large all-active target area
- UK backbox formats available
- Suitable for DDA environments



View the full range on pg.81

Reference	Description
RTE-85DL	All-active wheelchair logo switch
RTE-85E	All-active 'EXIT' switch
RTE-D	Large all-active wheelchair logo switch

### Recommended Posts

- High-grade stainless steel post
- Hardened grain finish
- UK-format cut-out for exit button mounting
- Suitable for outdoor or indoor use
- Available for next-day delivery



View the full range on pg.94

Reference	Description
RPSS-CUT	Stainless steel post with UK format cut-out

### Recommended Transmitters

- 1 to 4-channel transmitters
- Fully compatible with DIGIWAY door operators
- Hand-held or wall-mounted options available
- Suitable for indoor or outdoor use



View the full range on pg.45

Reference	Description
TX26-MC1	1-channel universal transmitter
TX26-TM	Wall-mounted transmitter
TX26-E4	4-channel hand-held transmitter

### Recommended Readers

- Standalone reader with self-contained electronics
- Up to 30 user capacity
- Built-in lock relay and exit button input
- Compatible with DTXT range cards (pg.29)



View the full range of readers on pg.23

Reference	Description
DTRR1434-R	Self-contained long-range reader

### Did you know..?



**DIGIWAY operators come with a built-in receiver as standard. If you need a cable-free solution, install a TX26-MC1 transmitter (pg.48) inside a reader post or exit button to trigger the DIGIWAY remotely!**



# Keypads

CDVI's range of keypads includes both remote and self-contained versions, with a variety of stylish aesthetic and robust vandal-resistant choices. The popular GALEO-4.0 also offers Bluetooth enablement for smartphone-assisted control.

The innovative Digicode® technology behind CDVI keypads ensures that they are designed to be quick and easy to install while reliably protecting people and property. Keypads can be used in their own right as part of an access control system, or combined with any audio or video entry system for a more complex solution.

Robust design and high resistance to vandalism make these keypads suitable for both residential and industrial sites. Built-in compatibility with all CDVI locking devices allows you to deliver a secure and cohesive security solution to every customer.

Contents	Page
GALEO-4.0	39
Self-Contained Keypads	40
Narrow-Style Keypads	41

## GALEO-4.0

GALEO-4.0 is an innovative keypad combining sleek and stylish aesthetics with robust security. With a remote electronic controller and vandal-resistant body, GALEO minimises the risk of the system being disabled through tampering.

- Manufactured in heavy-duty Zamak®
- Up to 100 user capacity
- 3 relays (pulse, timed, or latched)
- IK10 and IP64 rated
- 12V-24Vac / 12V-48Vdc
- 195mA



**IP 64**   **IK 10**



Meanwhile, GALEO is Bluetooth-enabled and its free iOS or Android app makes programming easier than ever. With a simple and intuitive interface, quickly set up all the key parameters directly from your smartphone.

- Connect directly to the controller
- Change or update access codes
- Configure relay types and timings
- Create and manage user profiles
- Unlock doors from within the app

Reference	Description
GALEO-4.0	Bluetooth-enabled backlit keypad with 3 relays



## DGA | Self-Contained Rugged Keypad

- Soft backlighting for convenience
- Vandal-resistant with Torx® screws
- Suitable for harsh environments
- Up to 100 user codes
- 2 timed/latching relays

- 12V to 24Vac / 12V to 48Vdc
- 25 to 80mA
- 120 x 98 x 25mm



IP 64	Reference	Description
	DGA	Self-contained rugged keypad with 2 relays

## CBB | Self-Contained Keypad

- High-grade stainless steel outer
- Vandal-resistant with DiAx® screws
- Up to 100 user codes and 3 relays
- Braille keys
- Secure surface mount

- 12V to 24Vac / 12V to 48Vdc
- 140mA
- 120 x 100 x 65mm



IP 54	Reference	Description
	CBB	Self-contained keypad with 3 relays

## CAASE | Self-Contained Flush Backlit Keypad

- High-grade stainless steel outer
- Vandal-resistant with DiAx® screws
- Up to 100 user codes
- Backlit illuminated keys
- Three output relays

- 12V to 24Vac / 12V to 48Vdc
- 140mA
- 125 x 100 x 3mm



IP 53	Reference	Description
	CAASE	Self-contained flush backlit keypad with 3 relays

## PROFIL100E | Narrow Backlit Keypad

- Keypad with integrated electronics
- Backlit with illuminated keys for convenience
- Vandal-resistant
- Narrow style to suit restrictive frames
- Up to 100 user codes

- 12V to 24Vac / 12V to 48Vdc
- 25 to 80mA
- 165 x 43 x 27mm



IP 64	Reference	Description
	PROFIL100E-INT	Narrow backlit keypad with built-in electronics

Want to know more about access control solutions?

Join us at the CDVI Academy!

Webinars

In-House

Online

#cdviacademy

See page 97 for more information



# Standalone Access Control

Standalone access control is a system for controlling access on one or more independent doors within a building. Standalone systems do not have a centralised control centre, as online systems do, but are instead programmed at the door using the reader's internal functions.

Standalone systems may utilise a keypad code or an access card or tag to control entry into a building or area. Due to the lack of a centralised management system in standalone access control, these solutions are recommended mainly for small commercial premises and storage units.

CDVI's standalone solutions include keypads with built-in card readers, as well as the popular STAR1M MIFARE® reader. This 2-in-1 reader can be customised for either online or standalone modes, and comes with a shadow card function for reducing the drawbacks of card management in standalone systems.

Contents	Page
SOLAR-2R	43
STAR1M	43
DTRR1434-R	43

### SOLAR-2R | 2-Door Modern Controller

- 125kHz reader with keypad
- Stylish aesthetic design
- Up to 1,000 users
- Includes remote electronics
- Audible and visual feedback
- 12Vdc
- 200mA
- 130 x 90 x 28mm



IP	Reference	Description
53	SOLAR-2R	2-door modern controller
IK	SOLAR-2RTM	Auxiliary reader

### STAR1M | Narrow Style MIFARE® Controller/Reader

- MIFARE® standard, stylish design
- Audible and visual feedback
- 2-in-1 access product with online/standalone modes
- Useful shadow card function - 150 card memory
- 12Vdc
- 120mA
- 130 x 41 x 28mm



IP	Reference	Description
54	STAR1M	Narrow style MIFARE® reader in black
IK	STAR1M-K	STAR1M Kit with 10 shadow cards
	STAR1M-SC	Shadow cards for STAR1M
	STAR1M-SC10	Shadow cards for STAR1M (pack of 10)
	STAR1M-SC50	Shadow cards for STAR1M (pack of 50)

### DTRR1434-R | Self-Contained Long-Range Reader

- Self-contained standalone reader/controller
- Built-in lock relay and exit button input
- Audible and visual signal
- Up to 30 users
- Compatible with DTXT access card range (pg. 29)
- 12 to 30Vdc
- 40mA
- 90 x 60 x 22mm



Reference	Description
DTRR1434-R	Self-contained long-range reader





# Transmitters & Receivers

CDVI's transmitters and receivers offer a full range of high-performance radio control and switching products, enabling wireless control of gates, barriers, doors, lights, and more.

With universal compatibility across the range, our transmitters and receivers are ideal options for incorporating into a comprehensive entry and security project.

Our transmitters are available with 1, 2, or 4 channels, with optional built-in proximity credentials for multi-technology access. In addition, Keeloq® rolling code ensures increased security by constantly updating transmitted signals.

Receivers come in internal or external formats, with high or low voltage input and different relay outputs with a range of different trigger inputs.

Contents	Page
High Security 128 Range	45
Transmitters	46
Receivers	50

## High Security

### TX128-E | Encrypted Transmitters

- 433.92 MHz
- AES128 encryption
- Up to 250m read range in open field
- Stylish dual-colour design
- 3V (CR2032 battery included)
- 72 x 36 x 12mm



Reference	Description
TX128-E2	2-channel high security transmitter
TX128-E4	4-channel high security transmitter

### RX128 | 128-bit Receivers

- 433.92 MHz
- Standalone and Wiegand (26, 30, and 44 bit)
- Timed, pulse, and latch operation
- IP55 (XPL) / IP2X (NANO)
- Memory for 500 transmitters (XPL)
- Memory for 248 user codes/85 push buttons (NANO)
- 12 or 24Vac/dc
- 123 x 81.5 x 41.5mm (XPL)
- 50 x 32 x 20mm (NANO)

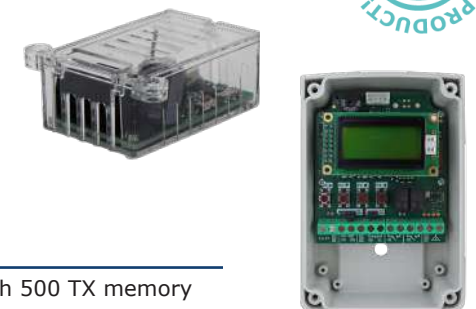

IP	Reference	Description
55	RX128-XPL	2-relay receiver with 500 TX memory
2X	RX128-NANO	1-relay 128-bit receiver

### Need an ultra-high security solution?



**For an ultra-secure solution, use these AES128-bit transmitters and receivers alongside the new KRYPTO high-security access control system.**

**The A22K controller supports up to 500 doors and 10,000 users with military-grade encryption technology.**

See page 6 for full details.



## TX26-E | Transmitters

- 1, 2, or 4-channel transmitters
- 433.92 Mhz
- Rolling Code Keeloq®
- Up to 250m read range in open field
- Wall holder available (SESMT03 - pg. 49)
- 12V (23A battery included)
- 83 x 48 x 16mm



Reference	Description
TX26-E1	1-channel transmitter
TX26-E2	2-channel transmitter
TX26-E4	4-channel transmitter

## TX26-T | Hand-Held Transmitters

- 1, 2, or 4-channel transmitters
- 433.92 Mhz
- Rolling Code Keeloq®
- Up to 250m read range in open field
- Stylish black and grey design
- 3V (CR2032 battery included)
- 72 x 36 x 12mm



Reference	Description
TX26-T1	1-channel hand-held transmitter
TX26-T2	2-channel hand-held transmitter
TX26-T4	4-channel hand-held transmitter

## TX26-AM | Mini Transmitters

- 433.92 Mhz
- Rolling Code Keeloq®
- Up to 200m read range in open field
- High security mini transmitter
- Available in two stylish designs
- 6V (2x CR2016 batteries included)
- 60 x 36 x 16mm



Reference	Description
TX26-AM1	1-channel mini transmitter
TX26-AM2	2-channel mini transmitter

## TX26-S7E4-ERN | Stylish Transmitter

- Stylish transmitter
- 433.92 Mhz
- Rolling Code Keeloq®
- Up to 250m read range in open field
- Innovative, robust, and stylish design
- 3V (CR2032 battery included)
- 70 x 40 x 13mm



Reference	Description
TX26-S7E4-ERN	4-channel high security transmitter

## TX26-TM | Wall-Mounted Transmitter

- 433.92 Mhz
- Rolling Code Keeloq®
- Up to 200m read range in open field
- Handy wall mount
- 3V (CR2032 battery included)
- 80 x 74 x 16mm



Reference	Description
TX26-TM	4-channel wall-mounted transmitter

## GALEO-R | 2-Channel Wireless GALEO Keypad

- 433.92MHz
- Wireless RF keypad
- Polished, high tensile alloy Zamak®
- Up to 200m read range in open field
- Backlit keys
- 3.6V (LS14500 battery included)
- 110 x 75 x 27mm



Reference	Description
GALEO-R	2-channel wireless GALEO keypad

## TX26-MC1 / SETMC1C9V

- 433.92MHz
- 1 transmission channel
- Turns a normally-open contact into an RF signal
- Up to 1km read range in open field
- Open connections (push-to-make)
- 9V (battery not included)
- 45 x 28 x 6mm



Reference	Description
TX26-MC1	1-channel universal transmitter

## TX26-M1 | Mains Supply Transmitter

- 433.92MHz
- Rolling Code Keeloq®
- Discreet triggered transmitter
- Up to 200m read range in open field
- IP2X rated
- 230Vac
- 50.5 x 40 x 16mm



IP 2X	Reference	Description
	TX26-M1	1-channel mains supply transmitter

## TX26-EXTB | Outdoor Transmitter

- Transmitter for outdoor use
- Rolling Code Keeloq®
- Up to 200m read range in open field
- Weather-resistant
- IP55 rated
- 230Vac - 50Hz
- 66.5 x 82 x 66mm



IP 55	Reference	Description
	TX26-EXTB	1-channel external transmitter

## TX26-TTHS | Touchless Transmitter

- 433.92MHz
- Radio touchless transmitter
- Suitable for outdoor installation (IP55 rated)
- 4cm activation range
- Audible and visual feedback
- ER14505 Lithium battery
- 105 x 70 x 23.5mm



IP 55	Reference	Description
	TX26-TTHS	1-channel radio touchless transmitter

## TX26-DIN | DIN Mount Transmitter

- 433.92MHz
- High security transmitter
- Rolling Code Keeloq®
- Up to 400m read range in open field
- Ideal for industrial and/or domestic use
- 12Vdc
- 60 x 90 x 30mm



Reference	Description
TX26-DIN	4-channel DIN mount transmitter

## SESMT03 | Wall Holder

- Wall holder for hand-held transmitters
- Comes in two sizes for use with different transmitters
- SESMT03 - suitable for TX26-E1, TX26-E2, & TX26-E4
- SESMT02 - suitable for TX39-E2 & TX39-E4



Reference	Description
SESMT03	Wall holder for use with TX26-E1, TX26-E2 & TX26-E4
SESMT02	Wall holder for use with TX39-E2 & TX26-E4



## Automatic Gate Triggers

Use a receiver to trigger an automatic gate to open, and keep a hand-held transmitter in your car for quick and easy entry.



## Garage Door Opening

Install the RX26-GDR receiver specifically designed for garage doors, and use hand-held transmitters to ensure safe and easy opening.



## Switching on Lights

Automatically turn on driveway or hallway lights to make access areas safe and well-lit when a signal is received from the transmitter.

### OPR-KIT | Universal Transmitter & NANO Receiver Kit

- Includes universal transmitter and NANO receiver
- Converts any N/O switch to a radio device
- Up to 200m read range in open field
- Ideal for use where wiring is impractical



Includes:

- TX26-MC1 1-channel universal transmitter (pg. 48)
- RX26-NANO 1-relay receiver (pg. 50)

Reference	Description
OPR-KIT	Universal transmitter & NANO receiver kit

### RX26-XPL & RX26-NANO

- 433.92MHz
- 1 or 2 relays
- Timed and pulse operation
- Polycarbonate housing for internal use



- 12 to 24Vac/dc
- 105 x 45 x 28mm (XPL)
- 50 x 32 x 20mm (NANO)

Reference	Description
RX26-NANO	1-relay NANO receiver
RX26-XPL	2-relay LCD display receiver

### RX26-XPL1 | 1-Relay Receivers

- 433.92MHz
- Keeloq® Hopping Code
- Easy-to-use LCD screen display
- Timed, pulse, and latch operation
- IP55 rated



- 12-24Vac/dc or 230Vac
- 123 x 81.5 x 41.5mm

Reference	Description
RX26-XPL1P	1-relay receiver, 12/24Vac/dc, 500 TX
RX26-XPL1V	1-relay receiver, 230Vac, 500 TX





## RX26-XPL2/4 | 2- and 4-Relay Receivers

- 433.92MHz
- Keeloq® Hopping Code
- Easy-to-use LCD screen display
- Timed, pulse, and latch operation
- IP55 rated
- 12 to 24Vac/dc or 230Vac
- 155 x 118 x 56mm



IP 55

Reference	Description
RX26-XPL2P	2-relay receiver, 12/24Vac/dc, 500 TX
RX26-XPL2V	2-relay receiver, 230Vac, 500 TX
RX26-XPL4P	4-relay receiver, 12/24Vac/dc, 500 TX
RX26-XPL4V	4-relay receiver, 230Vac, 500 TX

## RX26-XPL5 | 2- and 4-Relay Receivers

- 433.92MHz
- Keeloq® Hopping Code
- Easy-to-use LCD screen display
- Timed, pulse, and latch operation
- IP55 rated
- 12 to 24Vac/dc
- 123 x 81.5 x 41.5mm



IP 55

Reference	Description
RX26-XPL5	2-relay receiver, 12/24Vac/dc, 500 TX
RX26-XPL54	4-relay receiver, 12/24Vac/dc, 500 TX

## RX26-MF | 1-Relay Mains Powered Universal Receiver

- 433.92MHz
- Universal receiver
- Mains-powered
- Memory for 85 transmitters
- IP40 rated
- 230Vac input and output
- 51 x 40 x 16mm



IP 40

Reference	Description
RX26-MF	1-relay mains-powered universal receiver

## SELW-R433 | Radio Receiver

- Wiegand 26-bit radio receiver
- Single channel Wiegand output
- Up to 100m read range in open field
- Optional tuned antenna
- Compatible with all CDVI rolling code transmitters (pg. 45)
- 12/24Vac/dc
- 24mA
- 105 x 45 x 28mm



IP 2X

Reference	Description
SELW-R433	Radio receiver, Wiegand 26-bit

## SELW-2630MF | External Receiver

- Wiegand 26 or 30-bit radio receiver
- Suitable for outdoor use, ideal for gates and barriers
- Up to 100m read range in open field
- Optional tuned antenna
- Compatible with all CDVI rolling code transmitters (pg. 45)
- 12/24Vac/dc
- 24mA
- 109 x 109 x 56mm



IP 55

Reference	Description
SELW-2630MF	External receiver, Wiegand 26 or 30-bit

## Transmission Accessories

### SEA433

- Tuned aerial
- Increases sensitivity of receivers

### MEM-XPL

- 500 users additional memory
- Compatible with all XPL series receivers



Reference	Description
SEA433	Tuned aerial with L bracket and 3.5m cable
SEA433-L	Tuned aerial with L bracket and 6m cable
MEM-XPL	Backup memory for XPL receivers



# Electric Strikes

CDVI offer a wide variety of strikes in both EURO and ANSI format, from cost-effective mortice-mount options through to both medium and high-security strike locking solutions.

All CDVI EURO strikes come with a robust five-year warranty, and built-in MOVs (Metal Oxide Varistors) to ensure reliable performance in combination with access control systems (pg.4). With locking devices suitable for doors in wood, glass, aluminium, UPVC, and steel, as well as fire-rated doors and pedestrian gates, there is something for every project.

Monitored strikes have a built-in microswitch with NO/NC contacts, providing an anytime indication of the door status. In addition, the Constant Current Coils (CC) option allows for DC versions of fail secure strikes to be powered for extended periods without degrading the coil, improving longevity and durability.

Contents	Page
EURO Strikes	55
EURO Strikes Accessories	58
ANSI Strikes	59

## EURO Strikes

### GISIP | High Security Safety Strikes

- High security
- Fail safe NFS 61-937
- 450kg preload operation
- Holding force: 750kg
- Adjustable jaw as standard
- 12/24Vdc
- 400mA
- 134 x 23 x 39mm



Reference	Description
GISIP-12DR	High security safety strike, 12V, right-handed
GISIP-12DL	High security safety strike, 12V, left-handed
GISIP-24DR	High security safety strike, 24V, right-handed
GISIP-24DL	High security safety strike, 24V, left-handed

### WR Series | Weatherproof/Dustproof Strikes

- Weatherproof and dustproof to IP65 standard
- Fail secure lock
- Holding force: 400kg
- Manual hold-open function
- Built-in MOV
- 12Vdc
- 180mA
- 100 x 21.5 x 37mm



IP65	Reference	Description
	T2GE-12D	Weatherproof/dustproof strike, right-handed
	T2GE-12G	Weatherproof/dustproof strike, left-handed

### PR Series | Compact Strikes

- Super compact strike with radial jaw and adjustable jaw
- Non-handed and ideal for multi-point locking
- Holding force: 330kg
- Fire rated to 120 minutes
- 10V to 24Vac/dc
- @10V=230mA, @12V=280mA, @24V=560mA
- 67 x 16 x 25.5mm



Reference	Description
PRP	Fail secure strike, adjustable jaw, monitored
PR	Fail secure strike, adjustable jaw
PRI-P	Fail safe strike, adjustable jaw, monitored
PRI	Fail safe strike, adjustable jaw

## GPCF | Fire-Rated Strikes

- Symmetrical strike
- EN1634-1 Fire Rated to 120 minutes
- Holding force: 1000kg
- Supplied with faceplate (TG pg.58)
- 12Vac/dc or 24Vdc
- @12Vac=540mA, @12Vdc=630mA
- @12Vdc(CC)=380mA, @24Vdc(CC)=190mA
- 75.5 x 22 x 28mm



Reference	Description
GPCF-12CC	Fail secure strike, fire rated, 12Vdc, continuous
GPCFIP-12	Fail safe strike, fire rated, 12Vdc
GPCF-24CC	Fail secure strike, fire rated, 24Vdc, continuous
GPCFIP-24	Fail safe strike, fire rated, 24Vdc

## G Series | Strike Kits

- Surface and flush strike locking options in kit form
- Fail secure or fail safe options
- Fixed or adjustable jaw options
- Powder-coated steel
- Built-in MOV
- 12-24Vac/dc
- 105 x 50 x 36mm (GAE)
- 158 x 25 x 3mm (plate)



Reference	Description
GAE	Fail secure strike kit, 12Vac/dc, fixed jaw
GAEi-12	Fail safe strike kit, 12Vdc, fixed jaw
GAEi-24	Fail safe strike kit, 24Vdc, fixed jaw
GAE-12CC	Fail secure strike kit, 12Vdc, CC, fixed jaw
GAE-24CC	Fail secure strike kit, 24Vdc, CC, fixed jaw
GAER	Fail secure strike kit, 12Vac/dc, adjustable jaw
GAEiR-12	Fail safe strike kit, 12Vdc, adjustable jaw
GAEiR-24	Fail safe strike kit, 24Vdc, adjustable jaw
GAER-12CC	Fail secure strike kit, 12Vdc, CC, adjustable jaw
GAER-24CC	Fail secure strike kit, 24Vdc, CC, adjustable jaw

## S Series | Symmetrical Strikes

- Symmetrical strike
- Fail safe, fail secure, and monitored versions
- Holding force: 280kg
- Reversible
- Supplied with faceplate (TG pg.58)
- 12/24Vac/dc
- 75 x 28 x 20.5mm



Reference	Description
SR-12	Fail secure strike kit, 12Vac/dc, adjustable jaw
SIR-12	Fail safe strike kit, 12Vdc, adjustable jaw
SR-12CC	Fail secure strike kit, 12Vdc, CC, adjustable jaw
SPR-12CC	Fail secure strike kit, monitored, 12Vdc, CC, adjustable jaw
SPIR-12	Fail safe strike kit, monitored, 12Vdc, adjustable jaw
SR-24	Fail secure strike kit, 24Vac/dc, adjustable jaw
SIR-24	Fail safe strike kit, 24Vdc, adjustable jaw
SR-24CC	Fail secure strike kit, 24Vdc, CC, adjustable jaw
SR-1024	Fail secure strike kit, 10-24Vac/dc, adjustable jaw
SPR-1024	Fail secure strike kit, monitored, 10-24Vac/dc, adjustable jaw

## Electric Strike or Electric Lock?

### Electric Strike

More visible when installed from either side of the door

Can be installed quickly, easily, and more cheaply

Can be used in conjunction with an automatic door opener

### Electric Lock

Offers a cleaner, sleeker look that is less clearly visible

Installation is more involved and can cost more

Can be used on fire rated doors requiring a fail safe mode



## Faceplates

- Stainless steel faceplates
- Reversible
- Fit most CDVI EURO strikes
- 158 x 25 x 3mm (TG)
- 250 x 25 x 3mm (T290) with 17mm gap between latch and deadbolt



Reference	Description
TG	Stainless steel faceplate, 158mm
T290	Stainless steel faceplate, 250mm with deadbolt cut-out

## Housings

- Surface mount
- Grey, chrome, or brass finish
- Outward-opening door options
- Fit all CDVI SR Series strikes
- 135 x 34 x 24mm



Reference	Description
T204	Surface RIM case, grey finish
T205	Surface RIM case, chrome finish
T208	Surface RIM case, brass finish
T2080-G	Surface RIM case, outward opening, grey finish
T2080-B	Surface RIM case, outward opening, brass finish

## CPDT | Dead Bolt Position Contact

- Dead-bolt position contact
- Can be added to T290 faceplate
- 83.6 x 29 x 15.5mm



Reference	Description
CPDT	Deadbolt position contact

## ARU-M | Monitored ANSI Strikes

- Fail secure or fail safe switchable
- Monitored
- Holding force: 750kg
- Long and short faceplate supplied
- Accepts extension lips
- 12Vdc or 24Vdc options
- 165 x 32 x 2mm (long faceplate)
- 124 x 32 x 2mm (short faceplate)



Reference	Description
ARU-M	ANSI strike, 12Vdc, monitored
ARU-M24	ANSI strike, 24Vdc, monitored

## ELU | Extension Lips for ARU-M Series

- Extension lips for ARU-M Series only
- 25mm or 50mm versions



Reference	Description
ELU-25	25mm extension lip for ARU-M series
ELU-50	50mm extension lip for ARU-M series

## DBR-310 | Deadbolt Releases

- Fail secure or fail safe versions
- Stainless steel jaw
- Holding force: 900kg
- Heavy duty
- Monitored
- 12Vdc
- Max 120mA
- 150 x 32 x 25mm



Reference	Description
DBR-310FL	Deadbolt release, fail secure, monitored
DBR-310FS	Deadbolt release, fail safe, monitored



## Magnetic Architectural Handles

Magnetic architectural handles are becoming increasingly popular as sleek and aesthetic locking solutions requiring a stronger holding force. CDVI's range includes both shorter and full-height handles with holding force ranging from 300kg to 1200kg.

Handles can be fitted to doors in new projects, or retrofitted to existing doors where required, as well as being suitable for both indoor and outdoor use. For a more aesthetic solution, the handles can be powder-coated to a specific RAL colour to blend with the surrounding door frame.

The new EVO range (pg.61) also benefits from visual LED feedback for a stylish design solution.

Contents	Page
New EVO Range	61
Small Handles (<600mm)	63
Horizontal Profile Handles	63

### P300EVO | Architectural Handle 300kg Magnet

- Surface mount architectural handle
  - Retrofit or new build, aesthetic profile
  - 1x 300kg monitored magnet
  - LED light indicators
  - IP42 and IK10 rated
- 12/24/48Vdc (consumption per magnet)
  - @12Vdc=480mA, @24Vdc=240mA, @48Vdc=120mA

IP 42	Reference	Description
IK 10	P300EVO	Architectural handle, 1x 300kg monitored magnet, 400mm



### P600EVO | Architectural Handle 2x 300kg Magnets

- Surface mount architectural handle
  - Retrofit or new build, aesthetic profile
  - 2x 300kg monitored magnets
  - LED light indicators
  - IP42 and IK10 rated
- 12/24/48Vdc (consumption per magnet)
  - @12Vdc=480mA, @24Vdc=240mA, @48Vdc=120mA

IP 42	Reference	Description
IK 10	P600EVO	Architectural handle, 2x 300kg monitored magnet, 400mm



### BO600EVO | Architectural Handle 2x 300kg Magnets

- Surface mount full length architectural handle
  - Retrofit or new build, aesthetic profile
  - 2x 300kg monitored magnets
  - LED light indicators
  - IP42 and IK10 rated
- 12/24/48Vdc (consumption per magnet)
  - @12Vdc=480mA, @24Vdc=240mA, @48Vdc=120mA

IP 42	Reference	Description
IK 10	BO600EVO	Architectural handle, 2x 300kg monitored magnet, 2500mm





## BO900EVO | Architectural Handle 3x 300kg Magnets

- Surface mount full length architectural handle
- Retrofit or new build, aesthetic profile
- 3x 300kg monitored magnets
- LED light indicators
- IP42 and IK10 rated
- 12/24/48Vdc (consumption per magnet)
- @12Vdc=480mA, @24Vdc=240mA, @48Vdc=120mA



Reference	Description
BO900EVO	Architectural handle, 3x 300kg monitored magnet, 2500mm

## Did you know..?

Magnetic architectural handles are ideal for projects requiring a combination of strong holding force, sleek aesthetics, and ability to cope with high levels of regular traffic.

This makes them perfect for schools, halls of residence, or other public buildings with high footfall and a need for robust security.

The handles can be fitted on wooden, metal, and glass doors, as well as being suitable for both indoor and outdoor installation.



## P Range | 1x or 2x 300kg Magnets

- Surface mount architectural handle
- Retrofit or new build
- Aesthetic profile
- 1x or 2x 300kg monitored magnets
- 12-24Vdc per magnet
- @12Vdc=550mA, @24Vdc=275mA
- 400 x 105 x 63mm (P300RP)
- 600 x 105 x 63mm (P600RP)



Reference	Description
P300RP	Architectural handle, 1x 300kg monitored magnet, 400mm
P600RP	Architectural handle, 2x 300kg monitored magnet, 600mm

## PBO Range | 1x or 2x 400kg Magnets

- Surface mount architectural handle
- Retrofit or new build
- Aesthetic profile
- Suitable for wooden, metal, and glass doors
- 12-24Vdc per magnet
- @12Vdc=550mA, @24Vdc=275mA
- 400 x 126 x 68mm (PBO400RN40)
- 600 x 126 x 68mm (PBO800RN60)



Reference	Description
PBO400RN40	Architectural handle, 1x 400kg monitored magnet, 400mm
PBO800RN60	Architectural handle, 2x 400kg monitored magnet, 600mm

## BO600RH | Architectural Handle Horizontal Housing

- Surface mount architectural handle
- Horizontal profile
- Suitable for wooden, metal, and glass doors
- 12-24Vdc per magnet
- @12Vdc=550mA, @24Vdc=275mA
- 925 x 105 x 62mm



Reference	Description
BO600RH	Architectural horizontal profile housing, 2x 300kg monitored magnets



## BO600RP | 2x or 3x 300kg Magnets

- Surface mount architectural handle
- Retrofit or new build
- Aesthetic profile
- Suitable for wooden, metal, and glass doors

- 12-24Vdc per magnet
- @12Vdc=550mA, @24Vdc=275mm
- 2500 x 105 x 63mm



Reference	Description
BO600RP	Architectural handle, 2x 300kg monitored magnets, 2500mm
BO900RP	Architectural handle, 3x 300kg monitored magnets, 2500mm

## PRP-800 | Mimic Handle Section

- Mimic handle section
- For reverse side of door
- 2500mm length



Reference	Description
PRP-800	2500mm mimic handle section

## BO800RN | 2x 400kg Magnets

- Surface mount architectural handle
- Retrofit or new build
- Aesthetic profile
- Suitable for wooden, metal, and glass doors

- 12-24Vdc per magnet
- @12Vdc=550mA, @24Vdc=275mm
- 2500 x 136 x 68mm (BO800RN)
- 3000 x 136 x 68mm (BO800RN-3M)



Reference	Description
BO800RN	Architectural handle, 2x 400kg monitored magnets, 2500mm
BO800RN-3M	Architectural handle, 2x 400kg monitored magnets, 3000mm

## UBK Series | U Bracket for Architectural Handles

- U-bracket for architectural handles
- Suitable for glass doors
- Fits BO series architectural handles
- Provides secure fixing to glass doors
- Satin anodised aluminium
- 2500 x 62 x 33.5mm



Reference	Description
UBK-25	U-bracket for architectural handles
ADH-KIT	Glass fixing kit

## BO1200RN | 3x 400kg Magnets

- Surface mount architectural handle
- Retrofit or new build
- Aesthetic profile
- Suitable for wooden, metal, and glass doors

- 12-24Vdc per magnet
- @12Vdc=550mA, @24Vdc=275mm
- 2500 x 136 x 68mm (BO1200RN)
- 3000 x 136 x 68mm (BO1200RN-3M)



Reference	Description
BO1200RN	Architectural handle, 3x 400kg monitored magnets, 2500mm
BO1200RN-3M	Architectural handle, 3x 400kg monitored magnets, 3000mm

## REOMA | Spacers and Cable Trays

- Cable tray and spacer kit
- Kit includes 2x REO spacers and 2x ALMA cable trays
- Maximum 5 can be stacked
- 600 x 43 x 5mm (REO)
- 600 x 13 x 10mm (ALMA)



Reference	Description
REO	2500mm aluminium spacer
ALMA	2500mm cable tray
REOMA60	2x REO and 2x ALMA cable tray and spacer kit



## Electro-Magnetic Locks

Electro-magnetic locks consist of an electro-magnet and an armature plate. They are designed to be easy to install and offer both durability and longevity.

CDVI's range of electro-magnetic locks includes both internal and external locks in surface and mortice mount format. Many models offer visual LED indication and feedback, and the range includes architectural housings for an aesthetic finish. With holding force ranging from 180kg to 500kg, there's a suitable solution for every project.

The complete range of accessories (pg.73) includes Z&L brackets, fix kits, and door position monitors to complement any locking installation.

Contents	Page
Internal Surface Magnets	67
Internal Mortice Magnets	69
Architectural Housings	70
External Magnets	71
Magnetic Door Holders	72
Accessories	73

### V3 Series | Surface 300kg Magnetic Locks

- Surface mount magnetic locks
- Holding force: 300kg
- Monitored and buzzer option
- Innovative visual LED indication
- Z&L bracket available (pg.73)
- 12/24Vdc
- @12Vdc=550mA, @24Vdc=275mA
- 248 x 45 x 26mm



IP 42	Reference	Description
	V3SR	Surface 300kg magnetic lock, monitored
	V3SR-B	Surface 300kg magnetic lock, monitored with buzzer

### V4 Series | Surface 400kg Magnetic Lock

- Surface mount magnetic lock
- Holding force: 400kg
- Monitored
- Innovative visual LED indication
- Z&L bracket available (pg.73)
- 12/24Vdc
- @12Vdc=550mA, @24Vdc=275mA
- 255 x 50 x 27mm



IP 42	Reference	Description
	V4SR	Surface 400kg magnetic lock, monitored

### V5 Series | Surface 500kg Magnetic Locks

- Surface mount magnetic locks
- Holding force: 500kg
- Monitored and buzzer option
- Innovative visual LED indication
- Z&L bracket available (pg.73)
- 12/24Vdc
- @12Vdc=550mA, @24Vdc=275mA
- 266 x 66 x 40mm



IP 42	Reference	Description
	V5SR	Surface 500kg magnetic lock, monitored
	V5SR-B	Surface 500kg magnetic lock, monitored with buzzer

## V1SR | Surface 180kg Magnetic Lock

- Surface mount magnetic lock
- Holding force: 180kg
- Monitored
- Satin anodised aluminium
- Z&L bracket available (pg.73)
- 12/24Vdc
- @12Vdc=550mA, @24Vdc=225mA
- 167 x 34 x 21mm



IP 42	Reference	Description
	V1SR	Surface 180kg magnetic lock, monitored

## V3ER | 300kg Mortice Magnetic Lock

- Flush mortice mount magnetic lock
- Holding force: 300kg
- Monitored
- No moving parts
- Fits AT300-H series housings (pg. 70)
- 12/24Vdc
- @12Vdc=550mA, @24Vdc=275mA
- 228 x 39 x 27mm



IP 42	Reference	Description
	V3ER	Mortice 300kg magnetic lock, monitored

## SD Series | Double Surface Magnets

- Surface mount magnetic locks
- Holding force: 300kg or 500kg
- Monitored with LED indication
- Rounded edges and safety ropes
- 12/24Vdc
- @12Vdc=1.2A (600mA per side)
- @24Vdc=600mA (300mA per side)
- 496 x 45 x 26mm / 532 x 66 x 40mm



IP 42	Reference	Description
	SD300M	Double surface magnet, monitored, 300kg per side
	SD500M	Double surface magnet, monitored, 500kg per side

## V4ER | 400kg Mortice Magnetic Lock

- Flush mortice mount magnetic lock
- Holding force: 400kg
- Monitored
- No moving parts
- Ideal for sliding doors
- 12/24Vdc
- @12Vdc=550mA, @24Vdc=275mA
- 228 x 44 x 30mm



IP 42	Reference	Description
	V4ER	Mortice 400kg magnetic lock, monitored

## C Series | Single or Double Surface Magnets

- Surface mount magnetic locks
- Monitored with LED indication
- Single and double versions available
- 12/24Vdc
- @12Vdc=610mA, @24Vdc=305mA



IP 42	Reference	Description
	C3S11	Surface magnet, 300kg, monitored
	C5S11	Surface magnet, 500kg, monitored
	C3S12	Double surface magnet, 300kg, monitored
	C5S12	Double surface magnet, 500kg, monitored

## C3M11 | Entry-Level Mortice Magnet

- Entry-level mortice magnet
- Holding force: 300kg
- Monitored
- No moving parts
- Fits AT300-H series housings (pg.70)
- 12/24Vdc
- @12Vdc=550mA, @24Vdc=275mA
- 228 x 38 x 27mm



IP 42	Reference	Description
	C3M11	Entry-level mortice magnet, 300kg, monitored



## AT300 | Housings and Brackets

- Visually aesthetic housings and brackets
- Forms part of door frame
- Satin anodised aluminium finish
- Easy installation
- Fits C3M11 and V3ER mortice magnets (pg.69)
- 998 x 45 x 45mm (single door)
- 1998 x 45 x 45mm (double door)



Reference	Description
AT300-1H	1m housing with 1 cut-out
AT300-2-1H	2m housing with 1 cut-out
AT300-2-2H	2m housing with 2 cut-outs
AT300-2-2HV	2m housing with 2 cut-outs, vertical fix
AT300-1L	L-bracket for AT300-1 housings
AT300-2L	L-bracket for AT300-2 housings

## AT500 | Housings and Brackets

- Visually aesthetic housings and brackets
- Forms part of door frame
- Satin anodised aluminium finish
- Easy installation
- Comes with AT500M installed
- 995 x 70 x 50mm (single door)
- 1995 x 70 x 50mm (double door)



Reference	Description
AT500-1H	1m housing with AT500M magnet
AT500-2-1H	2m housing with AT500M magnet
AT500-2-2H	2m housing with 2x AT500M magnets
AT500-2-2HV	2m housing with 2x AT500M magnets, vertical fix
AT500-1L	L-bracket for AT500-1 housings
AT500-2L	L-bracket for AT500-2 housings

## External Surface Magnets

- External surface mount magnetic locks
- Ideal for use in harsh environments
- Stainless steel construction
- Monitored magnets
- Compatible brackets available (pg.73)
- 12/24Vdc
- @12Vdc=550mA, @24Vdc=275mA



Reference	Description
i180SR	External surface 180kg magnetic lock, monitored
i400SR	External surface 400kg magnetic lock, monitored
i500SR	External surface 500kg magnetic lock, monitored

## External Mortice Magnets

- External mortice mount magnetic locks
- Ideal for use in harsh environments
- Stainless steel construction
- Monitored magnets
- Up to 500kg holding force
- 12/24Vdc
- @12Vdc=550mA, @24Vdc=275mA



Reference	Description
i180ER	External mortice 180kg magnetic lock, monitored
i300ER	External mortice 300kg magnetic lock, monitored
i500ER	External mortice 500kg magnetic lock, monitored

## Micro Power Locks

- Ideal for automatic doors where conventional maglocks are too wide
- 2 years warranty
- Holding force: 680kg
- 12/24Vdc
- @12Vdc=280mA, @24Vdc=140mA



Reference	Description
HSM-600S	Single lock, direct fix with fixing plate
HSM-600SZ	Single lock for inward-opening door with Z bracket
HSM-600SB	Single lock for outward-opening door
HSM-600DB	Double lock for outward-opening door



## V250-D80R | Round 250kg Magnetic Lock

- Surface mount magnetic lock
- Suitable for internal or external use
- No residual magnetism
- Ideal for external barrier rooms
- Holding force: 250kg

- 12/24Vdc
- @12Vdc=440mA, @24Vdc=220mA
- 80mm diameter x 40mm



Reference	Description
V250-D80R	Round 250kg magnetic lock

## VIR Series | Wall- and Floor-Mounted Magnetic Door Holders

- Floor-mounted or wall-mounted
- Includes test button
- Holding force: 50kg
- CE EN1155 certified
- Fire rated to 60 minutes under EN1634-2

- 24Vdc
- 80mA
- 112 x 88 x 42mm (P5) / 80 x 88 x 42mm (A5)



Reference	Description
VIR-P5	Floor-mounted magnetic door holder
VIR-A5	Wall-mounted magnetic door holder

## SUP-VR-REG | Adjustable Wall/Floor Bracket for VIR-A5

- Adjustable bracket
- Fits wall-mounted magnetic door holder VIR-A5
- White powder-coated steel
- Provides a flexible solution



Reference	Description
SUP-VR-REG	Adjustable wall/floor bracket for VIR-A5

## L-Brackets

- L-shaped bracket
- Adjustable
- Satin anodised aluminium
- Suitable for 300kg, 400kg, and 500kg magnets

- 248 x 50 x 30mm (300L)
- 265 x 76 x 38mm (500L)



Reference	Description
300-L	Adjustable L-bracket for 300kg & 400kg magnets
300L-ADJ	Fully adjustable L-bracket for 300kg & 400kg magnets
500-L	Adjustable L-bracket for 500kg magnets
500L-ADJ	Fully adjustable L-bracket for 500kg magnets

## Z&L Brackets

- Z&L-shaped brackets
- Adjustable
- Satin anodised aluminium
- Suitable for up to 500kg magnets



Reference	Description
180-ZL	Z&L bracket for 180kg magnets
300-ZL	Z&L bracket for 300kg & 400kg magnets
300ZL-AC	Architectural Z&L bracket for 300kg & 400kg magnets
500-ZL	Z&L bracket for 500kg magnets
500ZL-AC	Architectural Z&L bracket for 500kg magnets

## 300-AS / 500-AS | Surface Armature Housings

- Surface armature housing
- Bevelled edges
- Cast aluminium (AS)
- Suitable for 300kg & 500kg magnets

- 188 x 54.5 x 15mm (300-AS)
- 193 x 74 x 14mm (500-AS)



Reference	Description
300-AS/500-AS	Surface armature housing for 300kg & 500kg magnets
300-ASE/500-ASE	Economy surface armature housing for 300kg & 500kg magnets with stackable spacer

## ES Brackets

- Z&L brackets for external magnets only
- Suitable for use with i400SR and i500SR (pg.71)
- Black powder-coated steel



Reference	Description
ESL-400	L-bracket for i400SR
ESL-500	L-bracket for i500SR
ESZ	Z-bracket for i400SR & i500SR

## KVU Fix Kits for Magnets

- Fixing kit with all necessary screws and bolts
- Universal solution for CDVI magnets
- Suitable for 300kg, 400kg, & 500kg magnets



Reference	Description
300-500-KVU	Universal fixing kit for magnets

## DPM Series | Door Position Monitors

- Monitors door position
- Retrofits to A-line single-surface magnets
- Saves fitting door contacts
- Changeover contact
- Suitable for 300kg, 400kg, & 500kg magnets
- 100mA contact rating



Reference	Description
DPM-300	Door position monitor for surface 300kg magnets
DPM-400	Door position monitor for surface 400kg magnets
DPM-500	Door position monitor for surface 500kg magnets

## UBK Series | Brackets and Glass Fixing Kit

- U-brackets for magnets and locking devices
- Suitable for use with glass doors
- Satin anodised aluminium
- Suitable for 300kg, 400kg, & 500kg armatures
- 185 x 62 x 33.5mm (UBK-U)
- 266 x 62 x 33.5mm (UBK-P)
- 2500 x 62 x 33.5mm (UBK-25)



Reference	Description
UBK-U	U-bracket for magnetic armatures
UBK-P	U-bracket for magnetic and electric locking
UBK-25	U-bracket for architectural handles
ADH-KIT	Glass fixing kit

## REOMA | Spacers and Cable Trays for Architectural Handles

- For use with magnetic architectural handles only
- Cable tray and spacer kit
- Kit includes 2x REO spacers and 2x ALMA cable trays
- Maximum 5 can be stacked
- 600 x 43 x 5mm (REO)
- 600 x 13 x 10mm (ALMA)



Reference	Description
REO	2500mm aluminium spacer
ALMA	2500mm cable tray
REOMA60	2x REO and 2x ALMA cable tray and spacer kit

## CDVI Support Centre

Have you visited the CDVI Support Centre yet?

[support.cdvi.co.uk](http://support.cdvi.co.uk)

Find step-by-step instructions for solving common installation problems and easy-to-follow explainer videos.

If you can't resolve your question, submit a Ticket and we'll get back to you as soon as possible.





# Electric Locks

Electric locks offer the ideal combination of fast and convenient access and monitoring, whilst providing reliable high security locking.

CDVI's range of electric locks includes both fail safe and fail secure models, each suited to different security contexts, solenoid bolts, self-aligning shearlocks, double-action locks, and motorised dead bolts. The holding force of the range starts at 650kg and goes up to 1500kg for high security settings.

Some models feature a built-in varistor, which effectively eliminates back-EMF and protects sensitive trigger devices such as keypads and access control units.

Contents	Page
DX-DY Range	77
Shearlocks	78
Additional Electric Locks	79

## Electric Locks

### DX-DY Range Solenoid Bolts

- Quick and easy to install
- Fail-secure locking
- Monitored locks
- Saw-proof roller bolt
- DY Series accredited by Rabbinical Court of Paris
- 12Vac/dc (ex.DX200)
- @12Vdc=1200mA, @12Vac=1500mA (ex.DX200)
- DX200: @12Vdc=250mA, @24Vdc=125mA



Reference	Description
DX200	Fail-safe solenoid bolt, monitored
DX200-SH	Stainless steel surface housing for DX200
DX22	22mm electric lock
DX32	32mm electric lock
DX50S	50mm electric lock
DY22	22mm electric lock with Rabbinical accreditation
DY32	32mm electric lock with Rabbinical accreditation
DY50S	50mm electric lock with Rabbinical accreditation

### Why choose a solenoid bolt?

Solenoid bolt locks are highly versatile locking solutions. Suitable for single and double swing doors as well as sliding doors, solenoid locks are often ideal where electric locks are not practical.

## POWERMAG25 | Narrow Shearlock and Housing

- Holding force: 800kg
- Fail safe locking
- Monitored
- Flush mount (surface housing PMAG-H available)
- Built-in electronic protection

- 12 to 24Vdc
- @12Vdc=460mA, @24Vdc=230mA
- 243 x 25 x 22mm



Reference	Description
POWERMAG25	Narrow style self-aligning shearlock
PMAG-H	Stainless steel surface housing for POWERMAG25

## CZ3000/CSL30 | Shearlock and Housing

- Holding force: 1500kg
- Fail safe locking
- Monitored
- Flush mount (surface housing CSL30-H available)
- Built-in electronic protection

- 12 to 24Vdc
- @12Vdc=600mA, @24Vdc=300mA
- 230 x 27 x 31.5mm



Reference	Description
CZ3000/CSL30	Self-aligning shearlock, flush mount
CSL30-H	Stainless steel surface housing for CZ3000

## SHL1200/P1200SHL | Traditional Shearlock and Housing

- Holding force: 1200kg
- Fail safe locking
- Monitored
- Flush mount (surface housing SHL1200-H available)
- Built-in electronic protection

- 12 to 24Vdc
- @12Vdc=630mA, @24Vdc=315mA (working)
- @12Vdc=1.8A, @24Vdc=900mA (inrush)
- 267 x 34 x 20mm



Reference	Description
SHL1200/P1200SHL	Traditional shearlock, flush mount
SHL1200-H	Surface housing for P1200SHL

## ML350 | Fire-Rated Electric Locks

- Holding force: 650kg
- Monitored compact electric lock
- Fail safe locking
- Operates under side load (up to 225kg)
- Robust construction

- 12 to 24Vdc
- @12Vdc=280mA, @24Vdc=140mA
- 200 x 25 x 41mm



Reference	Description
ML350-12V	Compact electric lock, 12Vdc, monitored
ML350-24V	Compact electric lock, 24Vdc, monitored
ML350-H	Surface housing for ML350

The ML350 range is fire rated to the EN14846 standard, tested for up to 60 minutes of fire resistance.



## MV Series | Motorised Dead Bolts

- Non-handed motorised dead bolt
- Audible signal for locking error
- Suitable for outdoor use
- Includes round cylinder and keys
- Ideal for doors and gates

- 12Vdc
- 120mA (working), 410mA (inrush)
- 126 x 96 x 42mm (body) / 96 x 40 x 36mm (keeper)



Reference	Description
MVA	Motorised electric dead bolt
MVM	Motorised electric dead bolt with manual override







# Accessories

CDVI offers a full range of accessories, ancillaries, and complementary devices to complete any door entry project from end to end.

Exit buttons and devices, including novel touchless models, are available in a variety of sizes, styles, and formats for any interior environment. All our push-buttons fit the standard UK back-box format, and can be mounted on the RPSS-CUT mounting post (pg.95). With the addition of a universal transmitter (TX26-MC1, pg.48), push-buttons can also be made wireless.

CDVI's range of key switches includes models with 2 or 3 positions in both standard and narrow style, as well as EURO key switches.

Further accessories include door loops, timers, relays, and infrared photocells - all designed to create a seamless and cohesive door entry solution.

Contents	Page	Contents	Page
Exit Buttons & Devices	81	Door Loops	86
Emergency Exit Devices	84	Timers & Relays	87
Key Switches	85		

# Exit Devices

## BP68LS | Stylish Push Button

- Modern, stylish aesthetic design
- Reflective backlight
- UK back-box format
- Suitable for internal use only
- Available in black or white

- 8-15Vdc
- 30mA
- 92 x 84 x 12mm



Reference	Description
BP68LS	Modern push button exit device

## RTE-IR | Infrared Exit Switch

- High quality stainless steel
- Touchless infrared trigger device, distance adjustable
- Simple to install
- UK back-box format
- Suitable for high traffic usage

- 12Vdc
- 80mA
- 85 x 85 x 42mm (surface), 85 x 85 x 6mm (flush)



Reference	Description
RTE-IRS	Infrared exit device, surface mount
RTE-IRF	Infrared exit device, flush mount

## NEW Aesthetic Infrared Exit Devices

- Stylish surface mount touchless infrared exit devices
- High-quality stainless steel finish
- Adjustable for time and distance
- RTE-AIR suitable for outdoor installation (IP68)
- Two-colour LED visual feedback

- 12/24Vdc
- 86 x 86 x 14mm (WIR)
- 80 x 32 x 23mm (AIR)



Reference	Description
RTE-AIR	Architrave infrared exit device
RTE-WIR	Wheelchair logo infrared exit device





## RTE Series | Plastic Exit Buttons

- Sturdy plastic frontage
- Suitable for internal use only
- UK back-box format
- High quality exit device

- Standard: 83 x 83 x 23mm (surface) / 5mm (flush)
- Architrave: 83 x 33 x 23mm (surface) / 5mm (flush)
- Wide: 83 x 83 x 23mm (surface) / 5mm (flush)



Reference	Description
RTE-001S	Standard plastic exit device, surface mount
RTE-001F	Standard plastic exit device, flush mount
RTE-002S	Architrave plastic exit device, surface mount
RTE-002F	Architrave plastic exit device, flush mount
BP-DOOR-S	Wide plastic exit device, surface mount
BP-DOOR-F	Wide plastic exit device, flush mount

## RTE-85 | All-Active Exit Buttons

- High quality stainless steel
- Large all-active target area
- Surface or flush mount
- UK back-box format
- Suitable for high-impact, high-traffic use

- 85 x 85 x 42mm (surface)
- 85 x 85 x 2mm (flush)



Reference	Description
RTE-85E	All-active exit device, surface mount, "EXIT" design
RTE-85EF	All-active exit device, flush mount, "EXIT" design
RTE-85DL	All-active exit device, surface mount, wheelchair logo
RTE-85DLF	All-active exit device, flush mount, wheelchair logo

## RTE-SS | Stainless Steel Exit Buttons

- Stainless steel plate
- Stainless steel / metal dome button
- UK back-box format
- Suitable for internal and external use
- Surface or flush mount

- Standard: 85 x 85 x 29mm (surface) / 2mm (flush)
- Architrave: 85 x 38 x 29mm (surface) / 5mm (flush)
- Green Dome: 85 x 85 x 29mm (surface) / 2mm (flush)



Reference	Description
RTE-SS	Standard stainless steel exit device, surface mount
RTE-SF	Standard stainless steel exit device, flush mount
RTE-AS	Architrave stainless steel exit device, surface mount
RTE-AF	Architrave stainless steel exit device, flush mount
RTE-SSD	Green dome stainless steel exit device, surface mount
RTE-SFD	Green dome stainless steel exit device, flush mount

## RTE-PTO | Large All-Active Exit Buttons

- High quality stainless steel
- Large all-active target area
- Surface or flush mount
- UK back-box format
- Suitable for DDA environments

- 130 x 130 x 72mm (surface, square)
- 130 x 130 x 14mm (flush, square)
- 114 x 43 x 43mm (surface, architrave)



Reference	Description
RTE-PTO	Large all-active "PUSH TO OPEN" exit device, surface mount
RTE-PTO-F	Large all-active "PUSH TO OPEN" exit device, flush mount
RTE-D	Large all-active wheelchair logo exit device, surface mount
RTE-DF	Large all-active wheelchair logo exit device, flush mount
RTE-PTODA	Architrave all-active wheelchair logo & "PUSH TO OPEN" exit device, surface mount

## EM Series | Emergency Door Releases

- Emergency unlock devices
- Suitable for internal use only
- UK back-box format
- Accessories available
- Double/triple-pole, breakglass/resettable options

- 30Vdc, 2A (EM200/201/301)
- 86 x 86 x 50mm (EM200/201/301)
- @12Vdc=75mA, @24Vdc=41mA (EM301-LS)
- 90 x 93 x 45mm (EM301-LS)



Reference	Description
EM200	Breakglass emergency door release, double-pole
EM201	Resettable emergency door release, double-pole
EM301	Resettable emergency door release, triple-pole
EM301-LS	Resettable emergency door release, triple-pole, with light and sounder
EM200-SPAREGLASS	Replacement glass for EM200
EMKEY	Spare reset key for EM201 (EM301-LS-KEY required for EM301 and EM301-LS)
MX-03	Protective cover for EM Series

## DBB Series | Combined Exit Buttons and Emergency Releases

- Surface mount combined exit device & emergency release
  - Suitable for internal use only
  - UK back-box format
  - Stainless steel buttons
  - Breakglass and resettable options
- 188 x 98 x 57mm



Reference	Description
DBB-21-02	Combined stainless steel exit button and breakglass emergency door release
DBB-21-04	Combined domed exit button and breakglass emergency door release
DBB-22-02	Combined stainless steel exit button and resettable emergency door release
DBB-22-04	Combined domed exit button and resettable emergency door release

## KS Series | Standard Key Switches

- Stainless steel standard square shape
- 2 or 3 position models (ask for references)
- Surface or flush models (ask for references)
- 85 x 85 x 30mm (surface)
- 85 x 85 x 2mm (flush)



Reference	Description
KEY-SSMAKA	Surface standard key switch, 2 position, maintained, keyed alike
KEY-SSMAKD	Surface standard key switch, 2 position, maintained, keyed to differ
KEY-SSMOKA	Surface standard key switch, 2 position, momentary, keyed alike
KEY-SSMOKD	Surface standard key switch, 2 position, momentary, keyed to differ

## KS Series | Narrow Key Switches

- Stainless steel architrave shape
- 2 position models
- Surface or flush models (ask for references)
- 85 x 38 x 30mm (surface)
- 85 x 38 x 2mm (flush)



Reference	Description
KEY-ASMAKA	Surface architrave key switch, 2 position, maintained, keyed alike
KEY-ASMAKD	Surface architrave key switch, 2 position, maintained, keyed to differ
KEY-ASMOKA	Surface architrave key switch, 2 position, momentary, keyed alike
KEY-ASMOKD	Surface architrave key switch, 2 position, momentary, keyed to differ

## Door Loops

- Ideal for cable/power management
- Quick and easy to install
- Minimum 7mm internal diameter
- Economical and vandal-resistant versions available



Reference	Description
FLEX-30	Compact metal door loop, 30cm
FLEX-60	Compact metal door loop, 60cm
GF45	Traditional door loop, 45cm
GF60	Vandal-resistant door loop, 60cm
GFI	Concealed door loop, 27cm

## Join the CDVI Community!



CDVI UK



@CDVIUK



@CDVIUK

Regular updates on all new products, company news, special offers, and more!



@CDVIUK

Follow the adventures of Charles and Jack, our adorable company mascots!



CDVI UK

Quick and simple videos to help installers and end users resolve product queries, as well as promotional videos showcasing our newest products.



## Timers & Relays

### TH Series

- 7-day timer, 8 on/off per day
- Battery backup
- Ideal for free access unlocking periods



### VHLR

- Universal relay, 12/24V
- 2x changeover contacts
- Ideal for van spares



### VHLD

- Convenient delay module, 12Vdc
- Simple lock release, no additional relay/timers
- 3-10 seconds adjustable timer



### TPG1

- Convenient relay and timer
- 0-15 seconds adjustable timer
- Ideal for door lock control



### ICM-2

- 2-door interlock control module
- Configurable for standard 2-door interlock or lock on door open (auto)
- Easy to install and programme



### SM1228

- Voltage reduction module
- Up to 1A load
- Ideal for locking where only 24Vdc is available



Reference	Description
TH827-12	Digital timer, 12Vac/dc
TH827-24	Digital timer, 24Vac/dc
TH827-240	Digital timer, 240Vac/dc
TH857	Digital timer, DIN rail mount, 230Vac
VHLR	Universal relay, 12/24V, double pole
VHLD	Delay module, 3-10 seconds, fail safe locks
TPG1	Relay/timer, 0-20 seconds
ICM-2	2-door interlock module
SM1228	Voltage reduction module





**ATRIUM is a powerful access control system offering end users full visibility and simple day-to-day management.**

**ATRIUM's unique 10-year warranty gives installers and customers the peace of mind of a reliable system.**

## CASE STUDY: MV Alfred Passenger Ferry

### THE PROJECT

A new high-tech vehicle and passenger ferry which travels daily between the north coast of Scotland and the Orkney Islands.

### THE CHALLENGE

Comply with maritime safety regulations to rigorously manage access to different parts of the ship.

### THE SOLUTION

A comprehensive installation of ATRIUM Access Control technology, securing 14 doors with magnetic locks and a card-controlled access system.

The system was designed by Clyde Technologies of Edinburgh, and installed by the shipyard in Vietnam which built the vessel. It was partially commissioned before leaving Vietnam and finally fully commissioned after a 9000-mile journey in Orkney in October 2019.

## CASE STUDY: Ribblesdale High School

### THE PROJECT

A new access control system for a high school in the heart of the Ribble Valley.

### THE CHALLENGE

To replace the ageing existing system with as little interruption to school life as possible, while designing a reliable solution to meet all the school's access control requirements.

### THE SOLUTION

A comprehensive ATRIUM access control system securing more than 30 doors, utilising magnetic locking and card control.

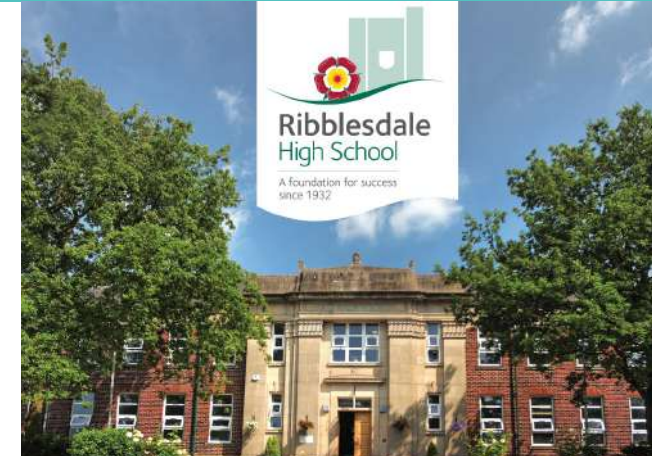

Installers EFT Systems were approached by the School after recommendation from LCC. Steve Ely, Head of Sales at EFT Systems, said ATRIUM ticked all the boxes for the project.



Eleven ATRIUM A22 controllers are networked to a computer installed on the ship's bridge.

Each door or gate is fitted with a reader for access cards and an exit switch for operating the magnetic lock.

In case of emergency, the captain can immediately unlock all doors with a single switch.



ATRIUM A22 controllers are installed in a cohesive network across the school building.

STAR-PB readers and electromagnetic locks are installed at each door offering card-controlled access.

Time schedules are configured on the ATRIUM software to align with the timings of classes throughout the day.



# Power Supplies

Power supplies are intended to supply power to low-voltage systems and to provide battery backup in the case of electrical failure in the mains supply.

CDVI's range includes linear and switching power supplies as well as transformers. Power supplies come in either standard-size or large metal cases, or can be DIN-mounted - select your products based on the needs of your installation.

Switch mode power supplies are ideal for access control solutions as well as general applications requiring standby battery capability.

CDVI products using switch mode technology are typically 85% efficient. This efficiency saves money for end users by reducing both their electricity bills and their carbon footprint. Switch mode technology also reduces the risk of overheating, making systems more reliable.

Contents	Page
DIN Mount Power Supplies	91
Transformers	92
PSU Series	93

## Power Supplies

### ADC335 | 3.5A 12Vdc Switching Power Supply

- Primary and secondary protection
- Sturdy, safe polycarbonate construction
- DIN rail mount
- High-efficiency switch mode
- 230Vac input, 12Vdc output
- 3.5A
- 91 x 54 x 58mm



IP 20	Reference	Description
	ADC335	12Vdc 3.5A switching power supply

### ARD-212 | 2A 12Vac/dc Power Supply

- Primary and secondary protection
- Sturdy, safe polycarbonate construction
- DIN rail mount
- Inputs and outputs protected by thermal fuse
- 12Vac/dc
- @12Vdc=2A, @12Vac=0.35A
- 142 x 92 x 60mm



IP 20	Reference	Description
	ARD-212	12Vac/dc 2A power supply

### ARD-24 | 1A 24Vdc Power Supply

- Primary and secondary protection
- Sturdy, safe polycarbonate construction
- DIN rail mount
- Regulated PSU
- 24Vdc
- 1A
- 142 x 92 x 60mm



IP 20	Reference	Description
	ARD-24	24Vdc 1A power supply



## CA1R | 12/24Vac Transformer

- High-quality transformer
- Short circuit protection
- DIN rail mount
- Ideal for keypads and fail secure electric strikes
- 24Vac
- 90 x 65 x 55mm



IP 54	Reference	Description
	CA1R	24Vac transformer

## CA1A | 12Vac Transformer

- High-quality transformer
- Short circuit protection
- Excellent value
- Ideal to run keypads and electric strikes
- 12Vac
- 81 x 56 x 43mm



IP 54	Reference	Description
	CA1A	12Vac transformer

## Did you know..?



**Switch mode power supplies offer many benefits for access control and door entry installations.**

**As well as the low heat generation and wide output range, switch mode power supplies typically offer 60-70% better power efficiency!**

## PSU Series

- Switch mode power supplies
- Additional battery charging current
- LED indication
- Short circuit protection
- Standard or large metal case
- 200 x 230 x 80mm (standard case)
- 330 x 355 x 80mm (large case)



Reference	Description
PSU12-1SM	12Vdc, 1A power supply, standard case
PSU12-2SM	12Vdc, 2A power supply, standard case
PSU24-2LSM	24Vdc, 2A power supply in large case
B7.5	7AH rechargeable battery

## CDVI Support Centre

**Are you having trouble installing or operating a CDVI product? Visit the CDVI Support Centre, where you'll find a wide range of FAQ videos and explanations.**

[support.cdvi.co.uk](http://support.cdvi.co.uk)







# Posts

CDVI offers a range of ready-made posts to complement and optimise any access control or door automation project. Balancing aesthetics and practicality, our posts are suitable for any non-coastal environment.

Posts are an ideal aesthetic mounting solution, with high-grade stainless steel and models covering both lorry and car/wheelchair users as well as pedestrians. The hardened grain finish offers a clean, modern design.

For projects with more focus on practicality, the GNP range of posts is ideally suited for car/lorry parks. Manufactured from steel and powder-coated in a black finish, these models are sturdy and robust.

CDVI's posts are all eligible for next-day delivery. Special options are also available and can be made on request.

Contents	Page
GNP Range	95
RPSS Range	95
SSP Range	96

## Posts

### GNP-1C | Car Height Goose Neck Posts

- Car-height post
- Goose-neck structure
- Sturdy construction
- Ideal for intercom or card reader mounting
- Black powder-coated steel or stainless steel
- 50mm sq. x 1000mm
- Next-day delivery



Reference	Description
GNP-1C	Car-height goose-neck post, black
GNP-1C-SS	Car-height goose-neck post, stainless steel

### GNP-1L | Lorry/Dual Height Goose Neck Posts

- Lorry-height post
- Goose-neck single or dual-height structure
- Sturdy construction
- Ideal for intercom or card reader mounting
- Black powder-coated steel
- 50mm sq. x 2100mm
- Next-day delivery



Reference	Description
GNP-1L	Lorry-height goose-neck post, black
GNP-2CL	Dual-height goose-neck post, black

### RPSS | Angled Top Stainless Steel Post

- Mounting post with angled top
- 304 high-grade stainless steel
- Hardened grain finish
- Suitable for outdoor installation
- Available with cut-out and base plate cover
- 100mm sq. x 1000mm
- Next-day delivery

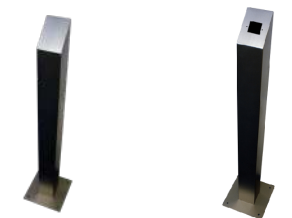

Reference	Description
RPSS	Angled top stainless steel post
RPSS-CUT	Angled top stainless steel post with UK format cut-out
RPSS-COLLAR	Base plate cover for RPSS and RPSS-CUT

**RPSS-100D | Round Stainless Steel Post**

- Round mounting post with angled top
- 304 high-grade stainless steel
- Hardened grain finish
- Suitable for outdoor installation
- 100mm diameter x 1000mm
- Next-day delivery



Reference	Description
RPSS-100D	Round angled top stainless steel post

**SSP-DDA-CAR | Wheelchair/Car Height Stainless Steel Post**

- Wheelchair-height mounting post
- 304 high-grade stainless steel
- Hardened grain finish
- Suitable for outdoor installation
- 100mm diameter x 1200mm
- Next-day delivery



Reference	Description
SSP-DDA-CAR	Wheelchair/car-height stainless steel post

**SSP-PED | Pedestrian Height Stainless Steel Post**

- Pedestrian-height mounting post
- 304 high-grade stainless steel
- Hardened grain finish
- Suitable for outdoor installation
- 100mm diameter x 1600mm
- Next-day delivery



Reference	Description
SSP-PED	Pedestrian-height stainless steel post

CDVI Academy brings a wide range of training opportunities to anyone looking to buy, sell, specify, or install CDVI products. CDVI Academy training is **always free, always friendly, and always safe**. In our brand-new training facility in High Wycombe, become an access control expert and certified installer of our access control, door automation, and video entry solutions.



**Our Courses**



**On-Site Training**

- Introduction to Access Control
- ATRIUM Installer Training
- DIGIWAY Installer Training
- 2EASY Video Entry Solutions



**Online Training**

- Getting Started with Access Control
- Getting Started with Door Automation
- Touchless Security Solutions
- CENTAUR Access Control



**96% of respondents rated our webinars as 4 or 5 star quality**

Aaron and the training team were fantastic and throughout the 2 days went into great detail and explanation about the products and all parameters in setting up the systems.

- DIGIWAY & ATRIUM on-site training attendee

**Sign up today!**



[www.cdvi.co.uk/training](http://www.cdvi.co.uk/training)





# 2EASY Video Entry

2EASY is an innovative video door entry system designed to provide a high-security, high-reliability solution that's simple to install and easy to operate.

Ideal for private and shared residential installations for up to 128-way video communication, 2EASY integrates seamlessly with ATRIUM Access Control for a comprehensive entry system. With just two wires required to set up 2EASY, and free installer training available from CDVI's in-house experts, it's easy to ensure every installation is a successful one.

With no monthly or annual subscription cost and a robust two-year warranty on all 2EASY products, end users benefit from the peace of mind of a trusted and secure system.

Contents	Page
Cables & Distances	99
1 & 2 Way Video Entry	100
Multway Video Entry	101

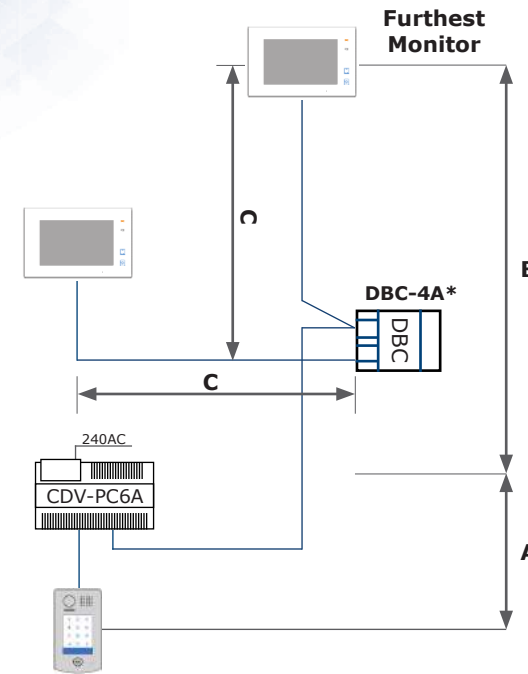

**Note:** CDVI do not recommend the use of parallel cables such as standard flex.

**\*Please Note:** The distance 'C' applies for the DBC4 when mounted either before the PC6 for entry panels or after the PC6 for internal monitors

Cable Type	A	B	C
0.79mm Unscreened TP (e.g. Belden 9740)	60m	80m	30m Max
1.34mm Unscreened TP (e.g. Belden 8471)	80m	80m	40m Max
CAT5/6n Copper*	40m	40m	30m Max

\*CAT5e can be used for a maximum of two monitors or two Entry Panels; all cores MUST be used - all stripes together and all solid colours together.

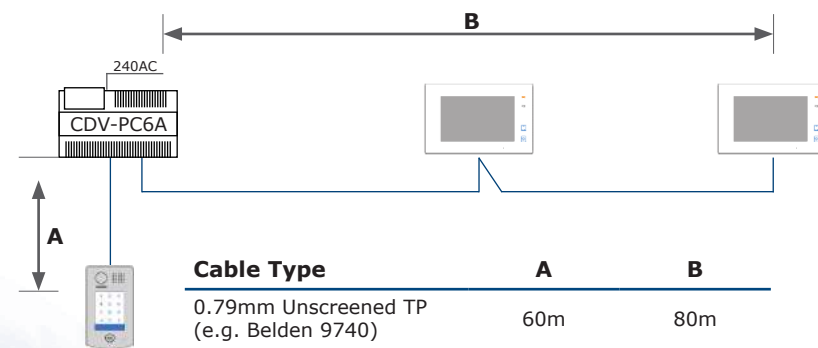

Cable Type	A	B
0.79mm Unscreened TP (e.g. Belden 9740)	60m	80m
1.34mm Unscreened TP (e.g. Belden 8471)	80m	80m
CAT5/6n Copper*	40m	40m

\*Cat5e can be used for a maximum of two monitors or two Entry Panels; all cores MUST be used - all stripes together and all solid colours together.



## 1 & 2 Way Colour Video Entry Kits

- Stylish black or white internal monitor
- Discreet door station in narrow style or with keypad
- Simple 2-wire connection for quick installation
- 2EASY app available on Android and iOS
- Kits contain:
  - CDV-47DX monitor in black or white
  - CDV-91S or CDV-96KP door station
  - CDV-PC6 wire



Reference	Description
CDV-4791S-DXB	1-way video entry kit. black monitor
CDV-4791S-DBW	1-way video entry kit, white monitor
CDV-4796KP-DXB	1-way video entry kit, black monitor and keypad
CDV-4796KP-DXW	1-way video entry kit, white monitor and keypad

## 1 & 2 Way Colour Video Entry Individual Products

- Simple 2-wire connection for quick installation
- 2EASY app available for WiFi-enabled systems

**NOTE:** Only one DX (WiFi-enabled) monitor is required per call button. Slave monitors (max. 3) must be CDV47B/W or CDV43.



Reference	Description
CDV-91S	1-button surface mount slim design door station
CDV-96KP	1-button surface stainless steel door station with keypad
CDV-971iD	1-button low-profile surface mount video door station with built-in proximity reader
CDV-972iD	2-button low-profile surface mount video door station with built-in proximity reader
CDV-47DX-B	7" interior monitor, black, WiFi app-enabled
CDV-47DX-W	7" interior monitor, white, WiFi-app enabled
CDV-43	4.3" interior monitor, white
CDV-B	2EASY monitor stand, desk mount, black
CDV-W	2EASY monitor stand, desk mount, white

www.cdvi.co.uk

## CDV97-ID | Colour Video Door Entrance Stations

- 170-degree colour camera
- Built-in proximity reader (10 proximity tags included)
- Low-profile surface mount
- Simple 2-wire connection for quick installation
- 4-button or 8-button models
- 24Vdc
- 0.8W (standby) / 3W (working)
- 176 x 90 x 27mm (4iD) / 280 x 110 x 44mm (8iD)



IP 54

Reference	Description
CDV-974iD	4-button low-profile surface mount video door station with built-in proximity reader
CDV-978iD	8-button low-profile surface mount video door station with built-in proximity reader

## CDV-DDP | Colour Digital Door Entrance Station

- Up to 128-way video communication
- Flush mount with surface housing available
- Built-in proximity reader and keypad
- Simple 2-wire connection for quick installation
- 24Vdc
- 33mA (standby) / 157mA (working)
- 350 x 128 x 46mm



IP 64

Reference	Description
CDV-DDP-F	Digital door station, up to 128-way video, flush mount
CDV-DDP-RH	Surface housing for CDV-DDP-F

## Did you know..?

**You can use the CDV-ACCS (pg.102) to connect 2EASY to your ATRIUM or CENTAUR access control system.**

**By converting data from proximity cards and tags at 2EASY door stations to Wiegand format, CDV-ACCS allows you to create a complete video access solution.**



## 2EASY Accessories

- All accessories required to install or expand a 2EASY video entry system
- CDVI recommends the UKC8471 cable for optimal operation
- Connection to ATRIUM access control system

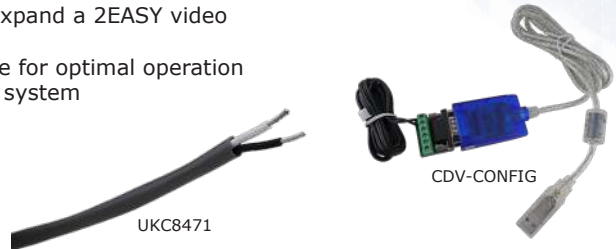

CDV-PC6



CDV-DBC4A



CDV-DBC4R



CDV-RLC



CDV-BDU



CDV-ACCS

Reference	Description
UKC8471	1-pair, 16AWG cable for 2EASY system, 100m
CDV-CONFIG	Software and cables for CDV-DDP panels
CDV-PC6	Power/Bus combiner unit
CDV-DBC4A	Bus splitter for additional handsets or door stations
CDV-DBC4R	Bus splitter for multiway systems using more than 8 DX monitors
CDV-RLC	Relay module (for second lock)
CDV-BDU	Bus amplifier to extend system capacity and cable length
CDV-ACCS	Addressable Wiegand signal converter for CDV-97 and CDV-DDP*

\*This Wiegand 26-bit signal converter for access control systems allows 2EASY systems to be connected to ATRIUM access control.

## Our Technical Support department is available from 8:30am to 5:30pm Monday to Friday.

### CDVI Support Centre



The Support Centre is an ever-growing library of FAQs and helpful videos to make it easy for you to solve queries independently.

Visit [support.cdvi.co.uk](http://support.cdvi.co.uk) or **YouTube**

### Technical Support - Phone



Call us from 8:30am-5:30pm Monday to Friday for direct help from our in-house product experts.

Call **+ [44] (0) 1628 531 300**

### Technical Support - Web Chat



For quick questions and advice, visit our website and get in touch using our web chat service during normal opening hours.

Visit [www.cdvi.co.uk](http://www.cdvi.co.uk)

### Out-Of-Hours Technical Support



If you have a question outside our normal hours, send us an email with your query. Photos are always helpful!

Email [technical@cdvi.co.uk](mailto:technical@cdvi.co.uk)



# CDVI

## Security to Access

### **CDVI Ltd**

Registered in England No. 3719229 | VAT No. GB 697 8358 55

Unit B1, Knaves Beech Business Centre  
Davies Way  
Loudwater  
Buckinghamshire  
HP10 9QR

+ [44] (0) 1628 531 300  
sales@cdvi.co.uk

[www.cdvi.co.uk](http://www.cdvi.co.uk)



### **CDVI Group**

France | Benelux | Iberica | Italy | Nordics  
Germany | Poland | Americas | Morocco  
[www.cdvigroup.com](http://www.cdvigroup.com)

## **PRODUCT CATALOGUE**

Date of Publication: January 2021

Every effort is made to ensure all information in this catalogue is correct at the time of publication, but it is offered without any guarantee and/or liability for completeness or correctness. Any information or images could be perceptibly different and we reserve the right to adjust, remove, or replace information or images without prior notice.